

05302500 - LT-A BMT55 DIN138-22 LR H85

Type	LT-A Tool holder angle 90°
Mounting	BMT 55
Tool output	Shell-Mill DIN138 22
Coolant	External coolant
Direction of rotation	r1 ↻ r2 ↻
Max speed [rpm]	6000
Max torque [Nm]	40
Ratio	1:1
H [mm]	85
H1 [mm]	32,5
Accessories	N.A.
Notes	N.A.
Mounting tips	N.A.

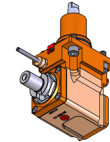

Always check live tool dimensions on the turret

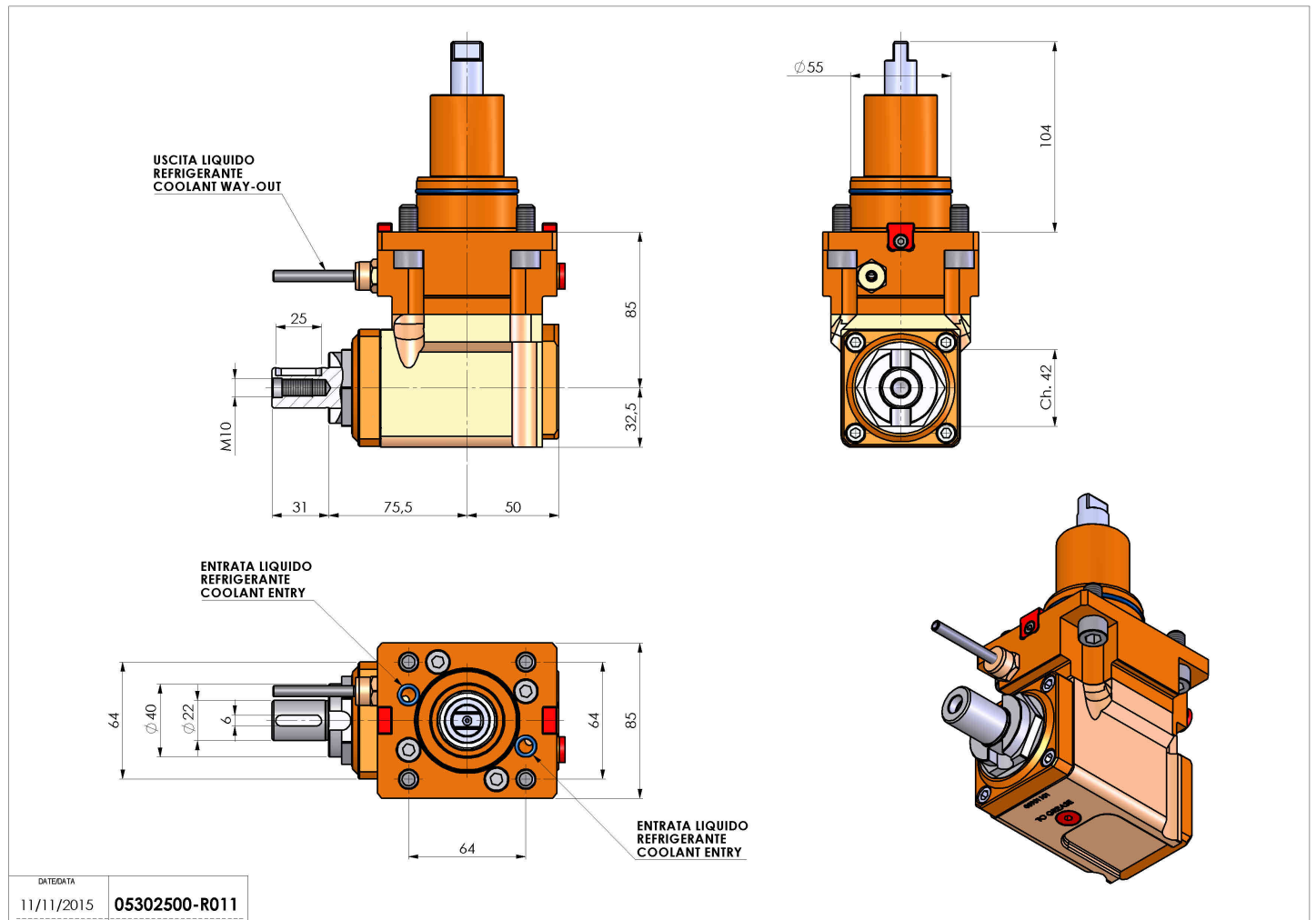

DATE/DATE	05302500-R011
11/11/2015	

Subject to technical changes