



# 05293100 - LT-S D32 C40 HRF H37

|                       |   |
|-----------------------|---|
| Type                  | LT-S<br>Tool holder straight  |
| Mounting              | CYLINDRICAL SHANK 32  |
| Tool output           | Polygonal shank C40 ISO 26623-1   |
| Coolant               | HRF Internal coolant  |
| Direction of rotation | r1  r2  |
| Max speed [rpm]       | 10000   |
| Max torque [Nm]       | 70  |
| Ratio                 | 1:1   |
| H [mm]                | 37  |
| Max pressure [bar]    | 70  |
| Accessories           | N.A.  |
| Notes                 | N.A.  |
| Mounting tips         | N.A.  |



Always check live tool dimensions on the turret

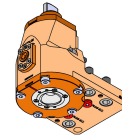
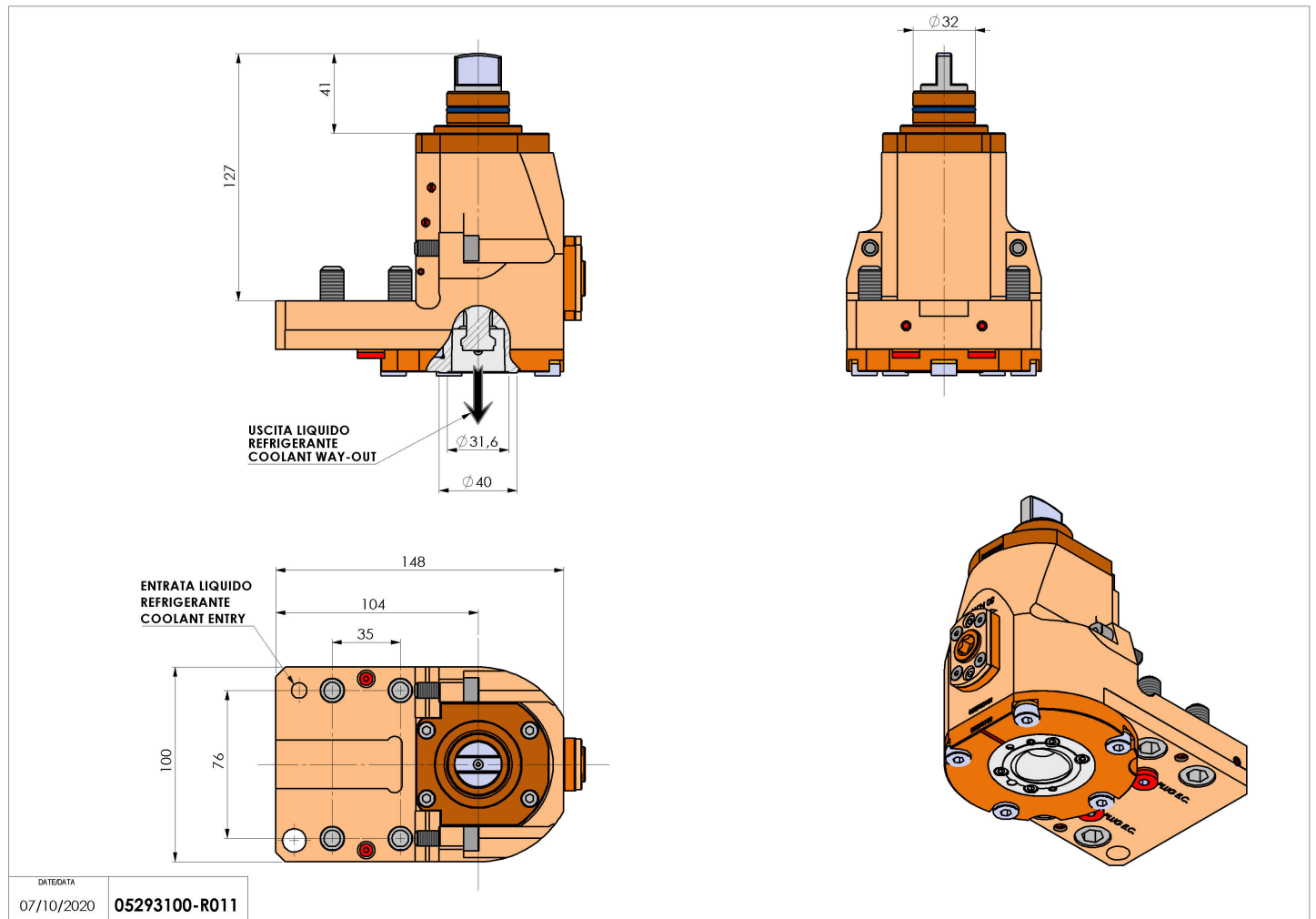

DATE/DATE  
07/10/2020 05293100-R011

Subject to technical changes