

05290800 - LT-A D32 C40 HRF HS H55

Type	LT-A Tool holder angle 90°
Mounting	CYLINDRICAL SHANK 32
Tool output	Polygonal shank C40 ISO 26623-1
Coolant	HRF Internal coolant
Direction of rotation	r1 r2
Max speed [rpm]	12000
Max torque [Nm]	70
Ratio	1:1
H [mm]	55
H1 [mm]	41
Max pressure [bar]	80
Accessories	N.A.
Notes	N.A.
Mounting tips	N.A.

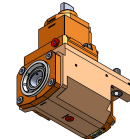

Always check live tool dimensions on the turret

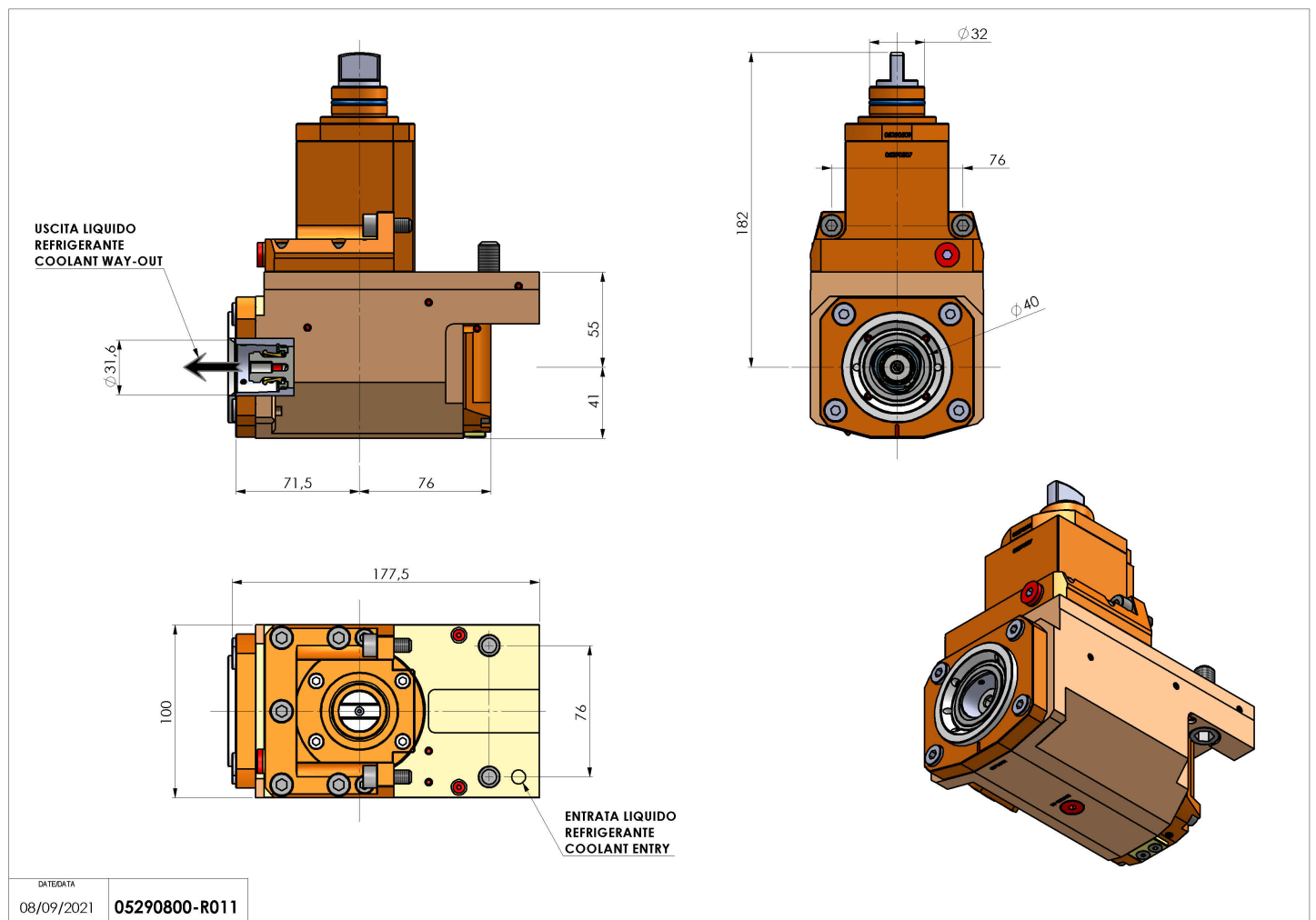

DATE/DATE	08/09/2021	05290800-R011
-----------	------------	---------------

Subject to technical changes