

05282200 - LT-A D54 ER25F-25F H75

Type	LT-A DBL Tool holder double angle 90°
Mounting	CYLINDRICAL SHANK 54
Tool output	Collet nut ER 25 F - internal nut
Coolant	External coolant
Direction of rotation	r1 ↻ r2 ↻ r3 ↻
Max speed [rpm]	6000
Max torque [Nm]	40
Ratio	1:1
H [mm]	75
H1 [mm]	37
Accessories	N.A.
Notes	N.A.
Mounting tips	N.A.

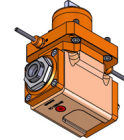

Always check live tool dimensions on the turret

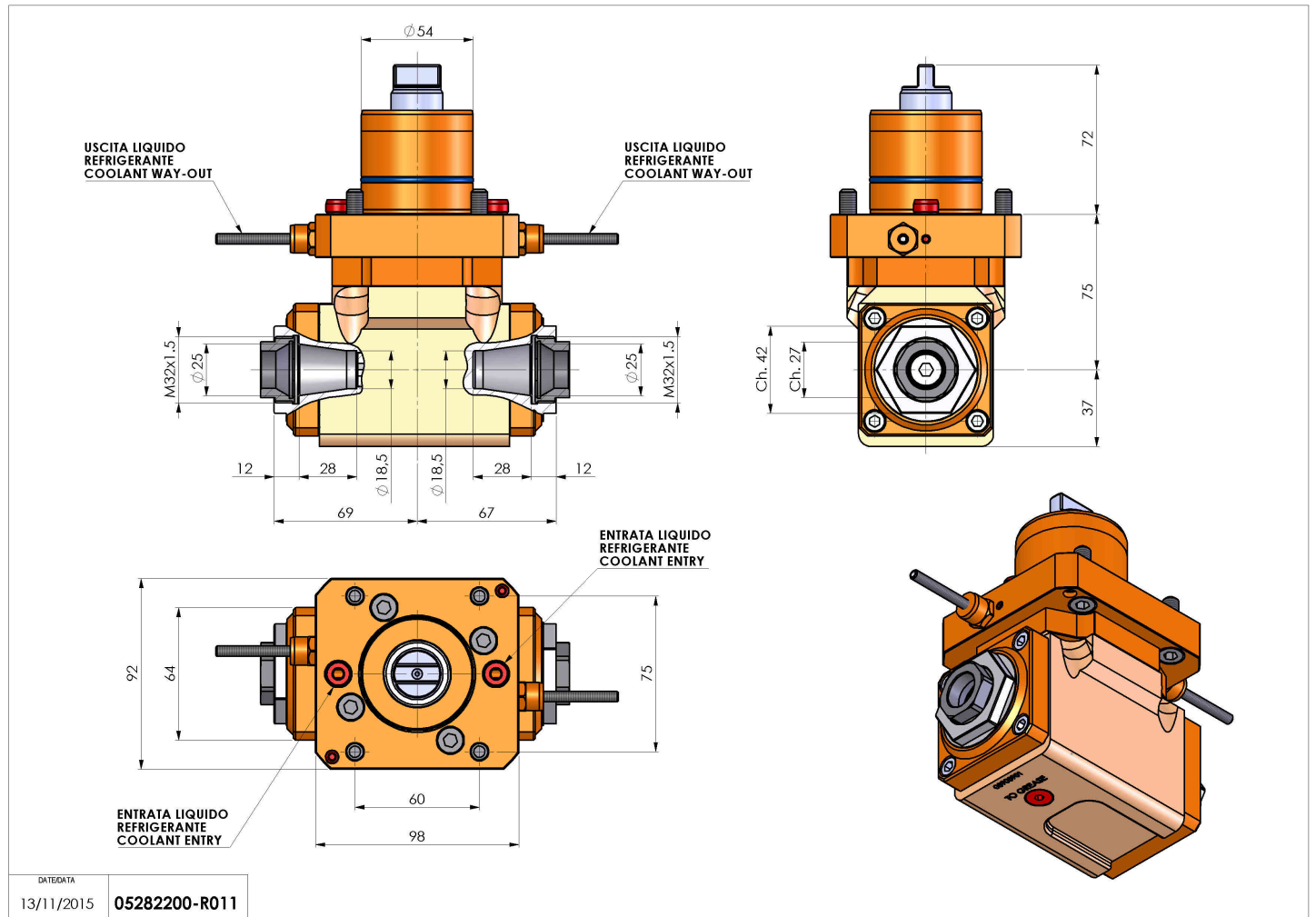

Subject to technical changes