

## 05269100 - LT-S D60 ER40 RF H85

<b>Type</b>	LT-S Tool holder straight
<b>Mounting</b>	CYLINDRICAL SHANK 60
<b>Tool output</b>	Collet nut ER 40
<b>Coolant</b>	Internal coolant
<b>Direction of rotation</b>	r1 ↻ r2 ↻
<b>Max speed [rpm]</b>	6000
<b>Max torque [Nm]</b>	40
<b>Ratio</b>	1:1
<b>H [mm]</b>	85
<b>Max pressure [bar]</b>	20
<b>Accessories</b>	N.A.
<b>Notes</b>	N.A.
<b>Mounting tips</b>	N.A.

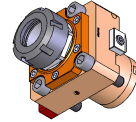

Always check live tool dimensions on the turret

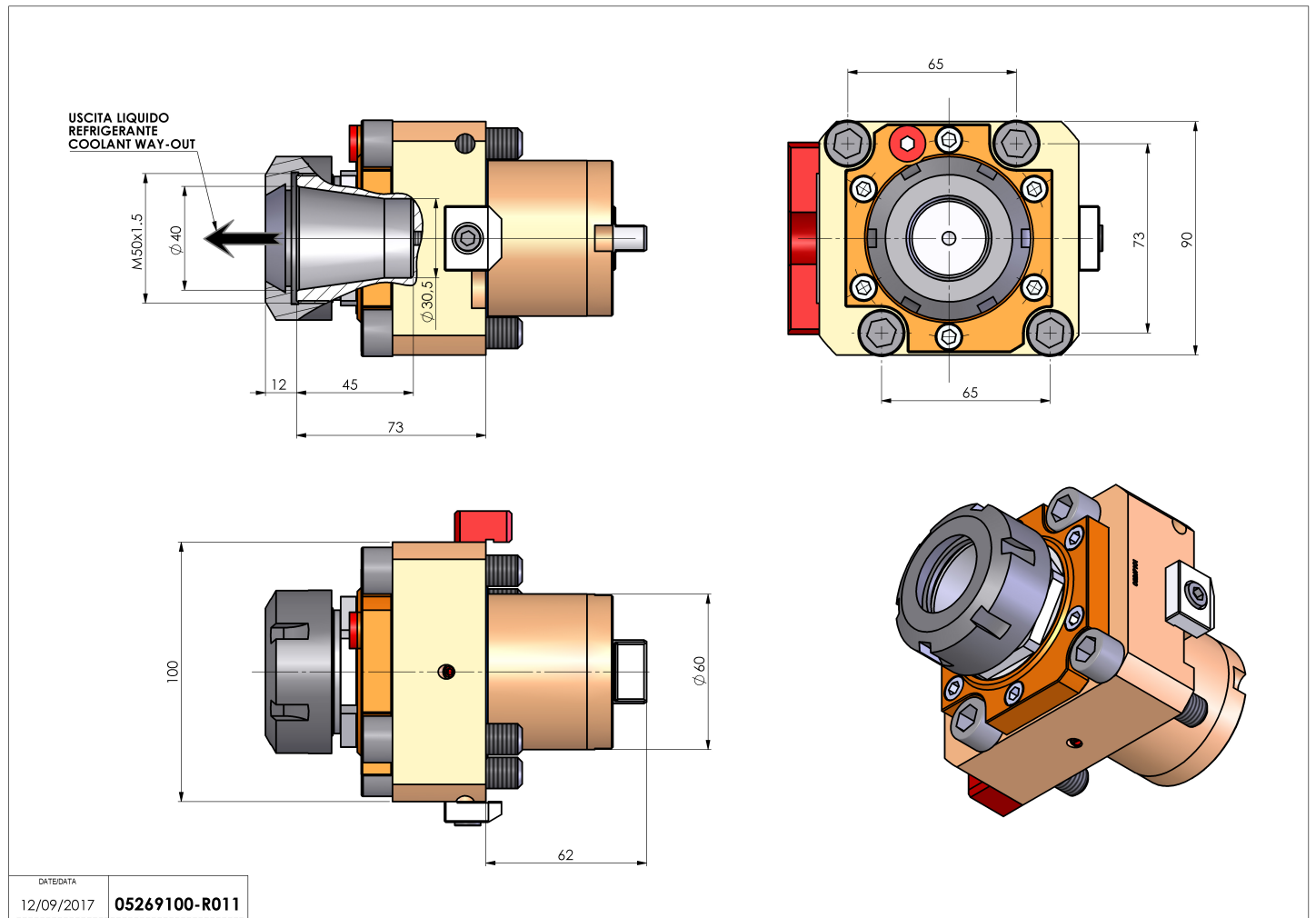

Subject to technical changes

DATE/DATE  
12/09/2017 05269100-R011