

## 05262800 - LT-A D55.4 WELDON16 LR H65 OK

|                              |                               |
|------------------------------|-------------------------------|
| <b>Type</b>                  | LT-A<br>Tool holder angle 90° |
| <b>Mounting</b>              | CYLINDRICAL SHANK 55,4        |
| <b>Tool output</b>           | Weldon 16 DIN1835B            |
| <b>Coolant</b>               | External coolant              |
| <b>Direction of rotation</b> | r1  r2                        |
| <b>Max speed [rpm]</b>       | 6000                          |
| <b>Max torque [Nm]</b>       | 40                            |
| <b>Ratio</b>                 | 1:1                           |
| <b>H [mm]</b>                | 65                            |
| <b>H1 [mm]</b>               | 32,5                          |
| <b>Accessories</b>           | N.A.                          |
| <b>Notes</b>                 | N.A.                          |
| <b>Mounting tips</b>         | N.A.                          |

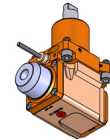

Always check live tool dimensions on the turret

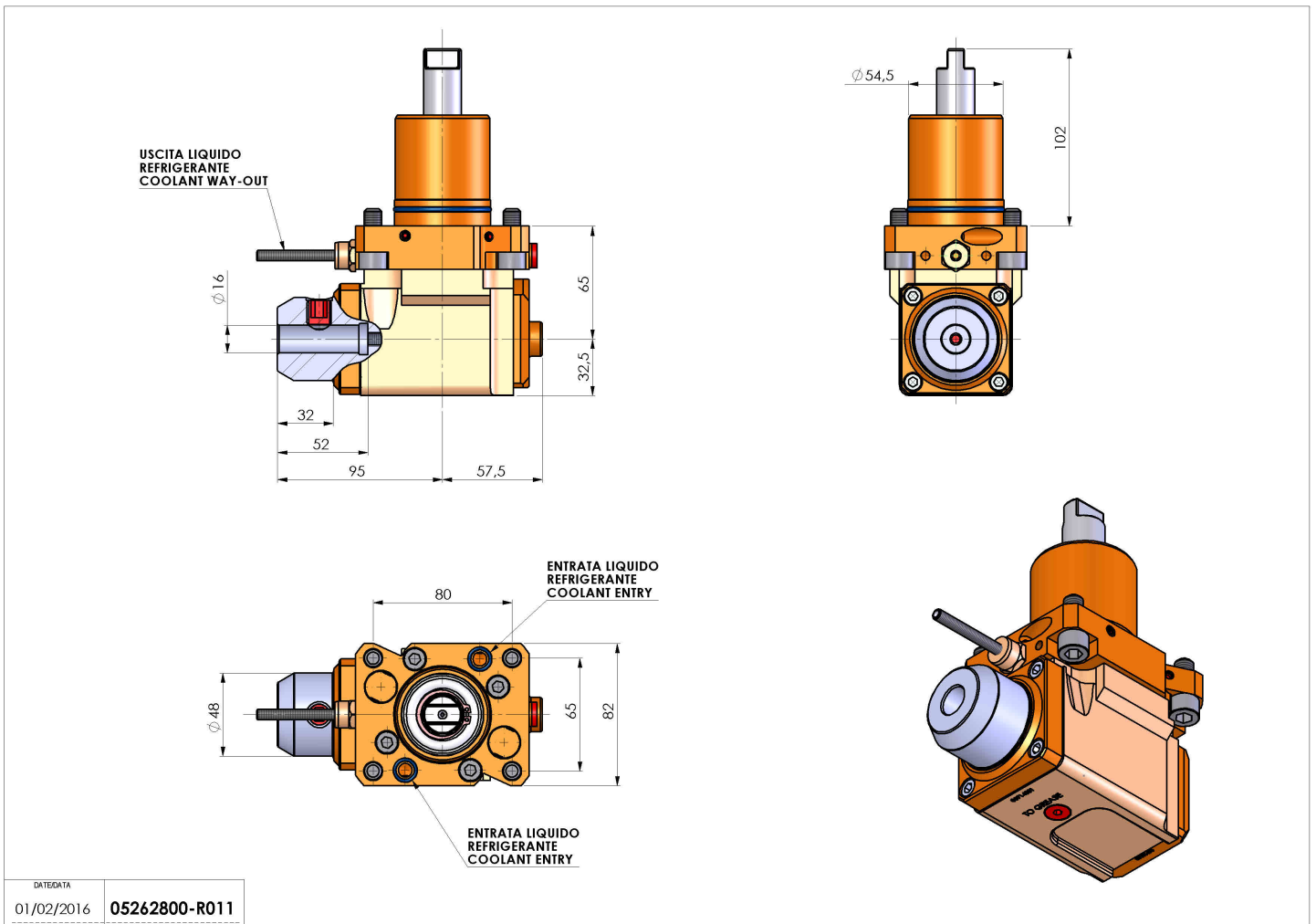

|            |                      |
|------------|----------------------|
| DATE/DATE  |                      |
| 01/02/2016 | <b>05262800-R011</b> |

Subject to technical changes