



# 05261100 - LT-S D60 ER32 H72

<b>Type</b>	LT-S Tool holder straight
<b>Mounting</b>	CYLINDRICAL SHANK 60
<b>Tool output</b>	Collet nut ER 32
<b>Coolant</b>	External coolant
<b>Direction of rotation</b>	r1  r2 
<b>Max speed [rpm]</b>	6000
<b>Max torque [Nm]</b>	40
<b>Ratio</b>	1:1
<b>H [mm]</b>	72
<b>Accessories</b>	N.A.
<b>Notes</b>	N.A.
<b>Mounting tips</b>	N.A.



Always check live tool dimensions on the turret

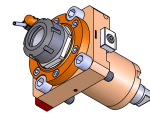
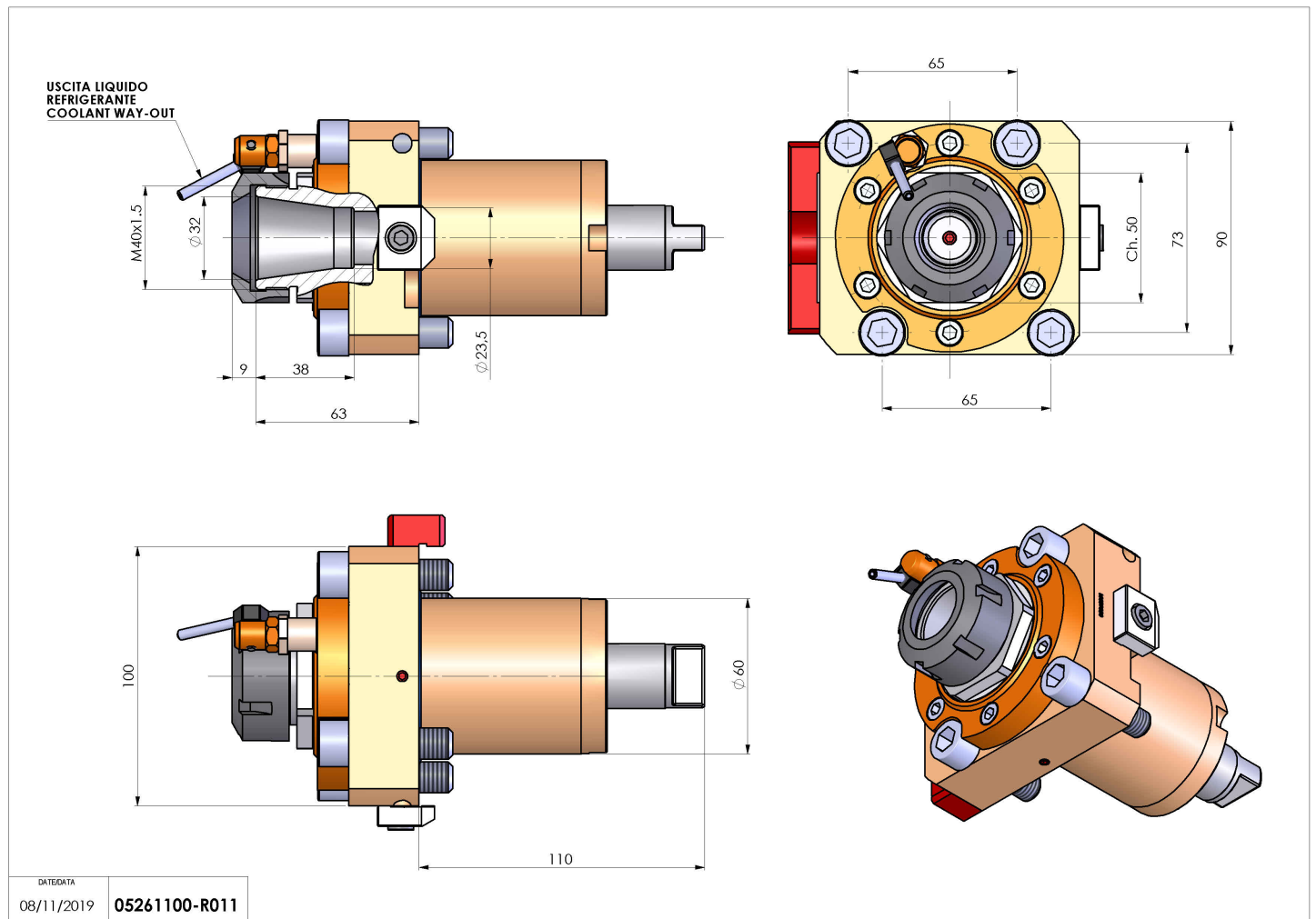

DATE/DATE	08/11/2019
	05261100-R011

Subject to technical changes