

05259200 - LT-T VDI40 ER16F H113-182 MZ

Type	LT-T Tool holder tiltable
Mounting	VDI 40
Tool output	Collet nut ER 16 F - internal nut
Coolant	External coolant
Direction of rotation	r1 ↻ r2 ↻
Max speed [rpm]	6000
Max torque [Nm]	10
Ratio	1:1
H [mm]	113-182
Accessories	N.A.
Notes	N.A.
Mounting tips	N.A.

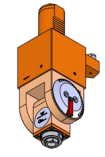

ATTENTION: CHECK THE ORIENTATION OF THE VDI TEETH

Always check live tool dimensions on the turret

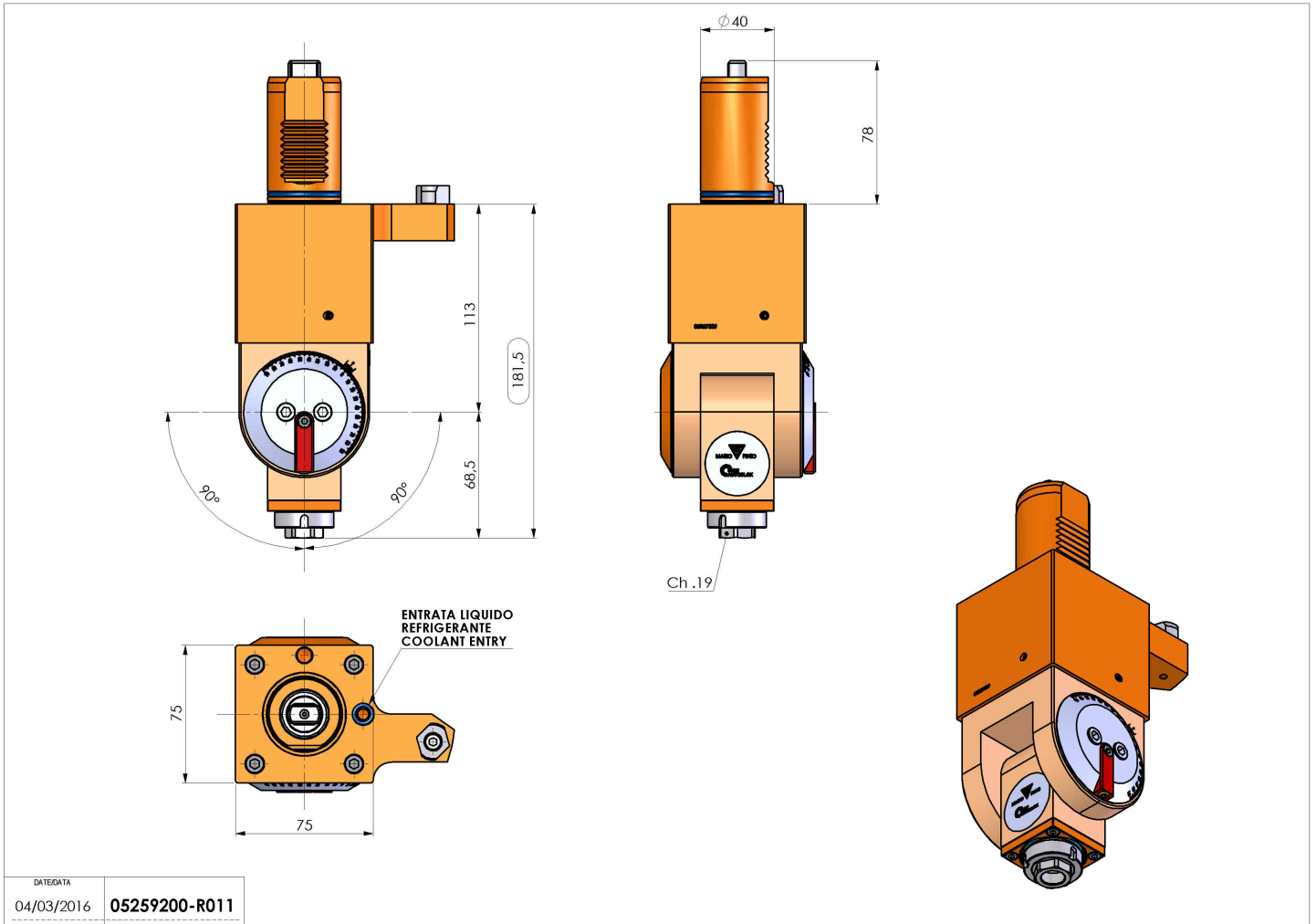

DATE/DATE: 04/03/2016 **05259200-R011**

Subject to technical changes