

05250900 - LT-S VDI40 ER32F OFS50 H95 MZ

Type	LT-S OFS Tool holder straight offset
Mounting	VDI 40
Tool output	Collet nut ER 32 F - internal nut
Coolant	External coolant
Offset [mm]	50
Direction of rotation	r1 ↻ r2 ↻
Max speed [rpm]	6000
Max torque [Nm]	63
Ratio	1:1
H [mm]	95
Accessories	N.A.
Notes	N.A.
Mounting tips	Main spindle only



ATTENTION: CHECK THE ORIENTATION OF THE VDI TEETH

Always check live tool dimensions on the turret

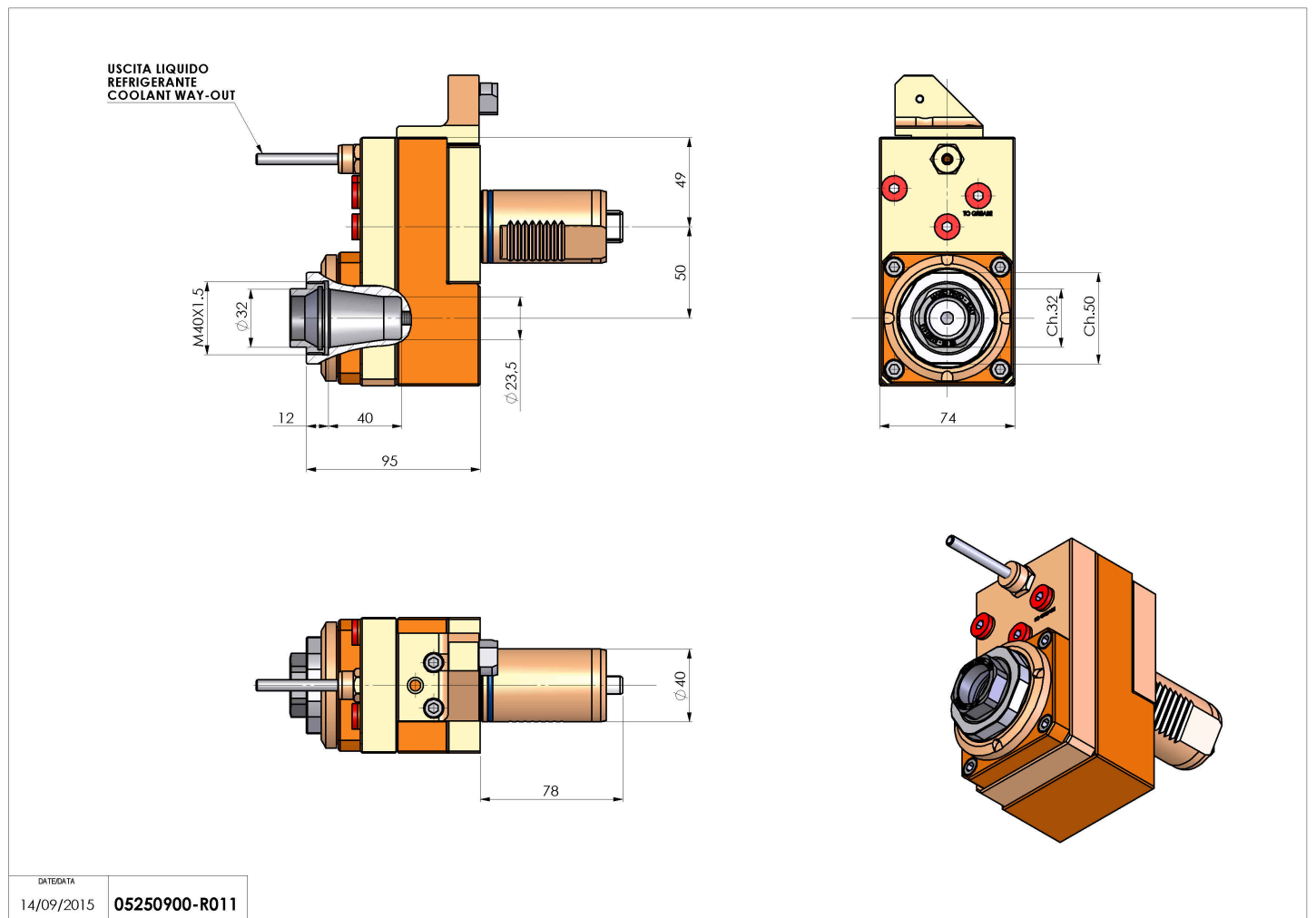

Subject to technical changes