

05244500 - LT-S D40 ER32F HS H70

Type	LT-S Tool holder straight
Mounting	CYLINDRICAL SHANK 40
Tool output	Collet nut ER 32 F - internal nut
Coolant	External coolant
Direction of rotation	r1 ↻ r2 ↻
Max speed [rpm]	12000
Max torque [Nm]	40
Ratio	1:1
H [mm]	70
Accessories	
Notes	N.A.
Mounting tips	N.A.

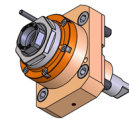

Always check live tool dimensions on the turret

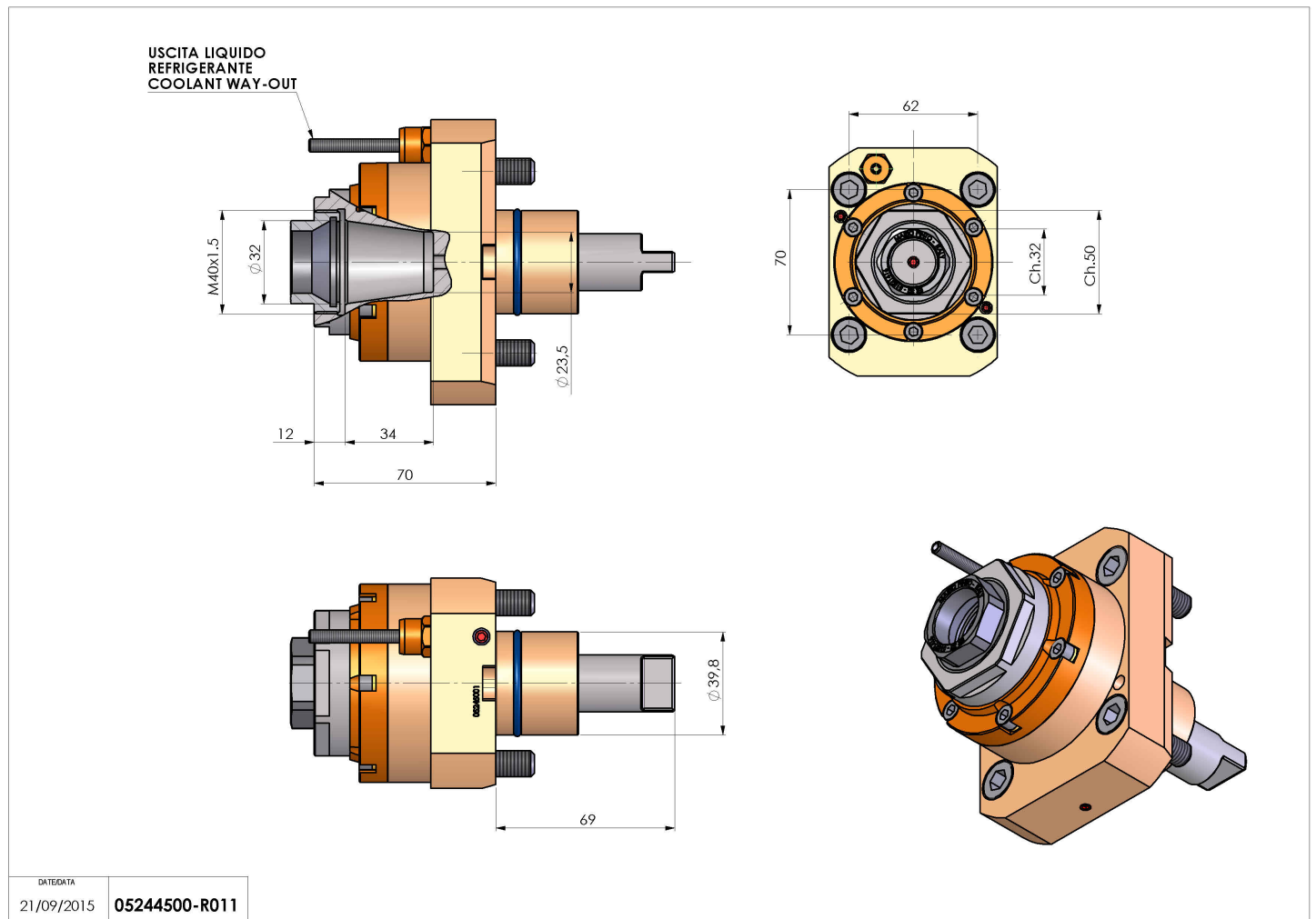

DATE/DATE	05244500-R011
21/09/2015	

Subject to technical changes