

05177900 - LT-T VDI50 ER20F H71-151 BA

Type	LT-T Tool holder tiltable
Mounting	VDI 50
Tool output	Collet nut ER 20 F - internal nut
Coolant	External coolant
Direction of rotation	r1 ↻ r2 ↻
Max speed [rpm]	6000
Max torque [Nm]	20
Ratio	1:1
H [mm]	71-151
Accessories	N.A.
Notes	N.A.
Mounting tips	N.A.

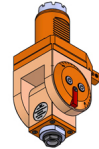

ATTENTION: CHECK THE ORIENTATION OF THE VDI TEETH

Always check live tool dimensions on the turret

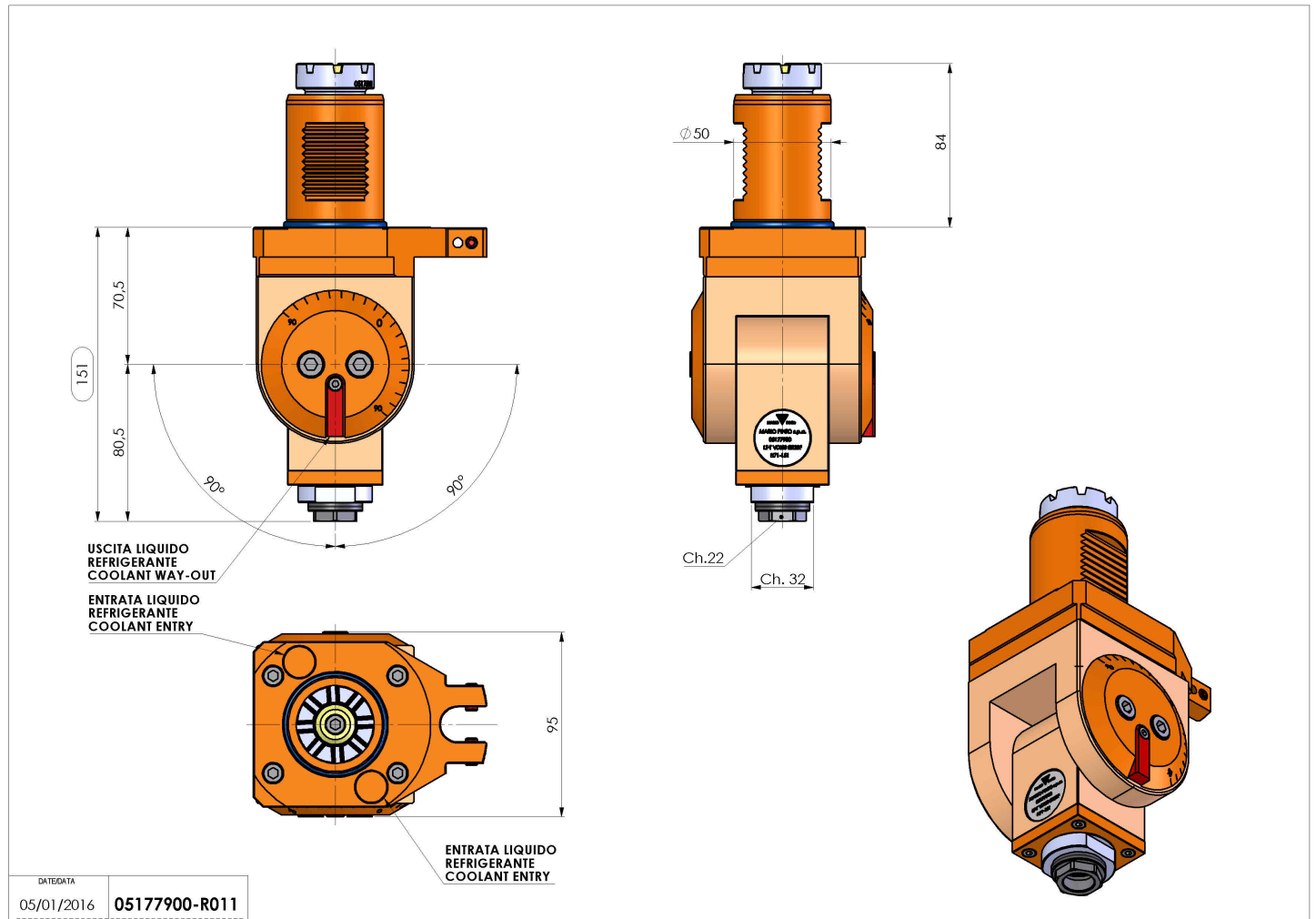

Subject to technical changes