

# 05175800 - LT-A VDI50 DIN-27 L-R H105 BA

<b>Type</b>	LT-A Tool holder angle 90°
<b>Mounting</b>	VDI 50
<b>Tool output</b>	Shell-Mill DIN138 27
<b>Coolant</b>	External coolant
<b>Direction of rotation</b>	r1 ↻ r2 ↻
<b>Max speed [rpm]</b>	6000
<b>Max torque [Nm]</b>	80
<b>Ratio</b>	1:1
<b>H [mm]</b>	105
<b>H1 [mm]</b>	38
<b>Accessories</b>	N.A.
<b>Notes</b>	N.A.
<b>Mounting tips</b>	N.A.

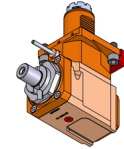

**ATTENTION: CHECK THE ORIENTATION OF THE VDI TEETH**

Always check live tool dimensions on the turret

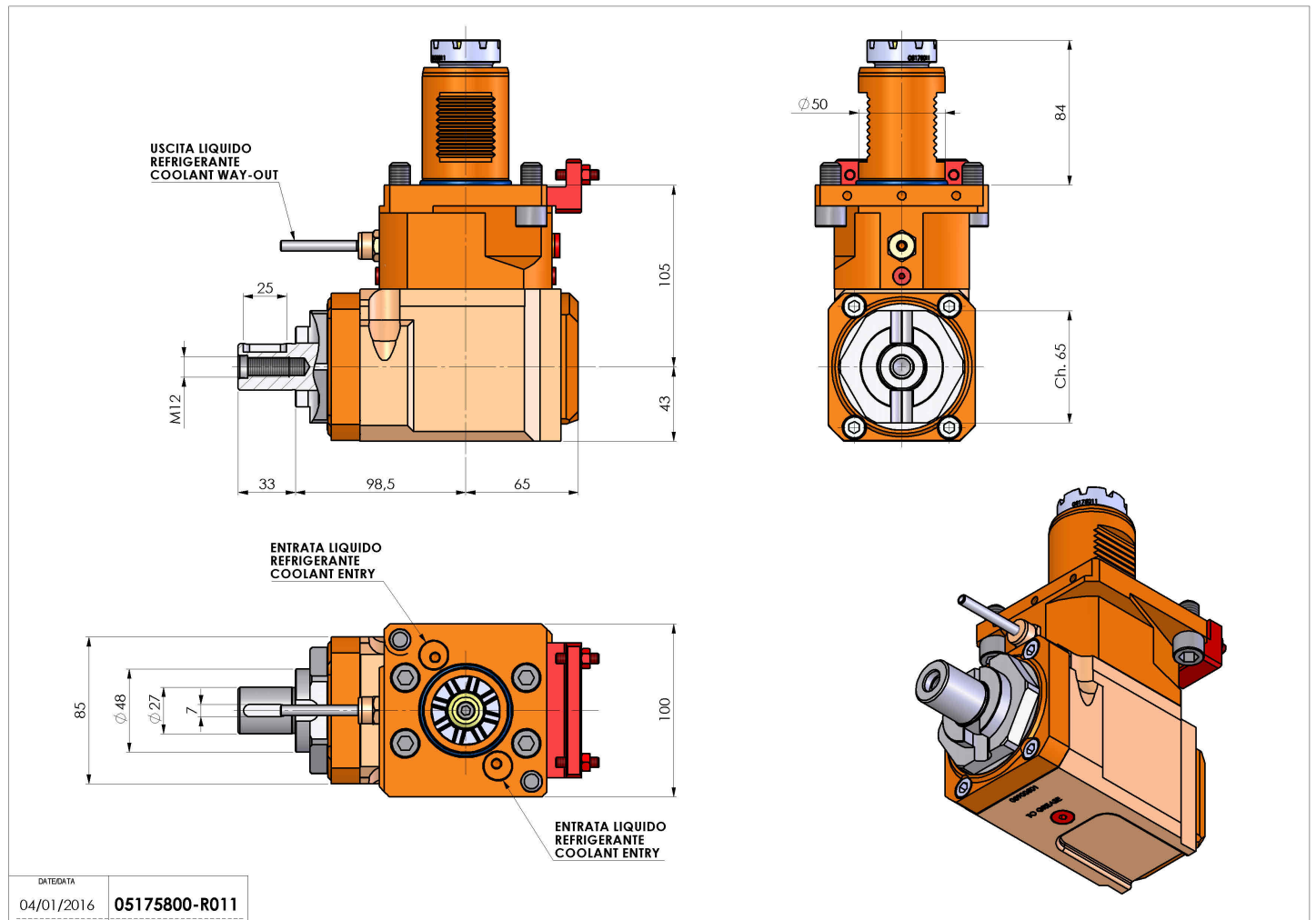

DATE/DATE	04/01/2016
	05175800-R011

Subject to technical changes