

05174200 - LT-A VDI30 ER25F-25F LR H90 BA

Type	LT-A DBL Tool holder double angle 90°
Mounting	VDI 30
Tool output	Collet nut ER 25 F - internal nut
Coolant	External coolant
Direction of rotation	r1 ↻ r2 ↻ r3 ↻
Max speed [rpm]	6000
Max torque [Nm]	30
Ratio	1:1
H [mm]	90
H1 [mm]	34
Accessories	N.A.
Notes	N.A.
Mounting tips	N.A.

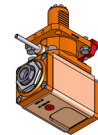

ATTENTION: CHECK THE ORIENTATION OF THE VDI TEETH

Always check live tool dimensions on the turret

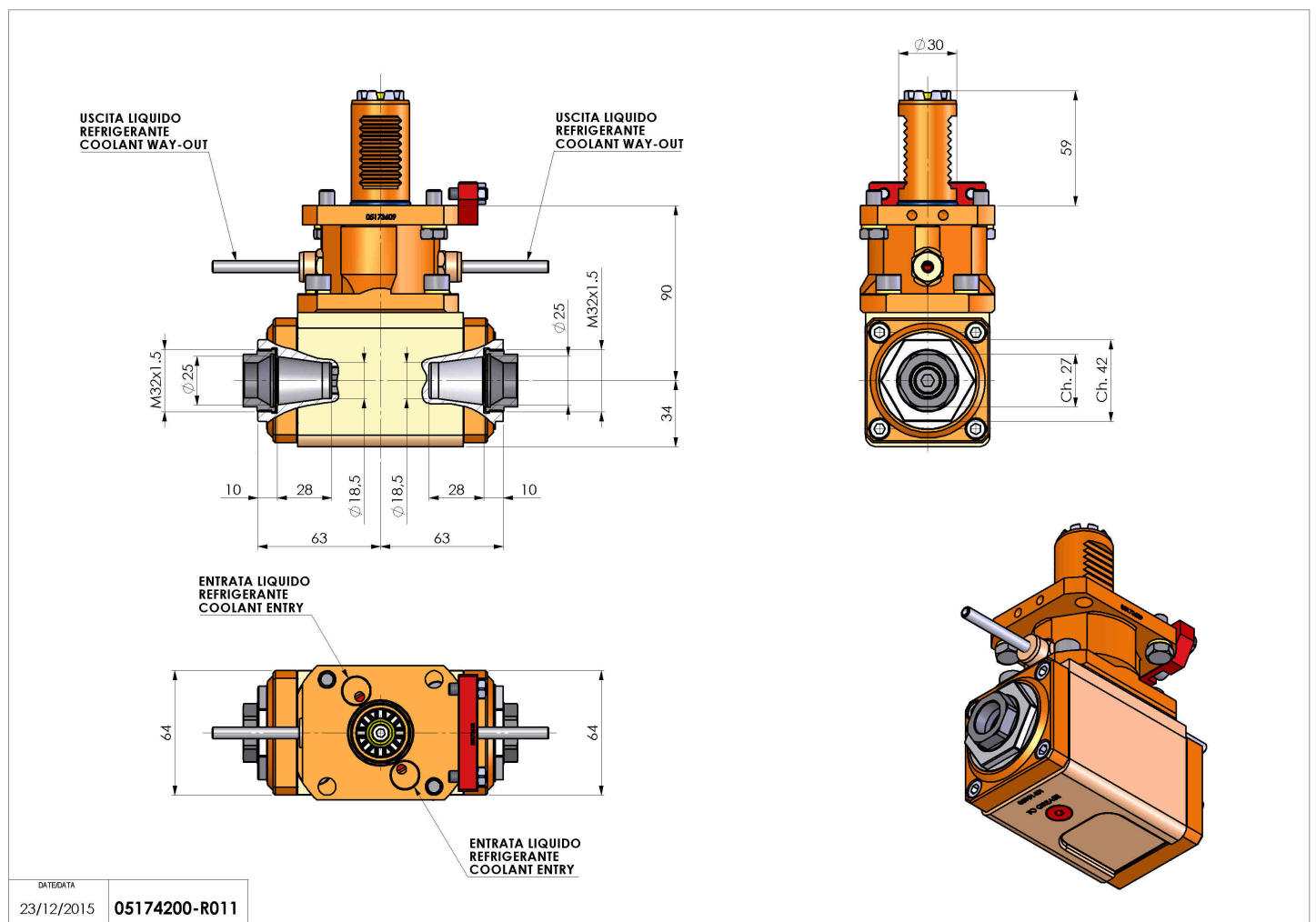

DATE/GATE	05174200-R011
-----------	---------------

Subject to technical changes