



## 05152900 - LT-A VDI40 C40 HRF H140

|                       |   |
|-----------------------|---|
| Type                  | LT-A<br>Tool holder angle 90°   |
| Mounting              | VDI 40  |
| Tool output           | Polygonal shank C40 ISO 26623-1   |
| Coolant               | HRF Internal coolant  |
| Direction of rotation | r1  r2  |
| Max speed [rpm]       | 6000  |
| Max torque [Nm]       | 63  |
| Ratio                 | 1:1   |
| H [mm]                | 140   |
| H1 [mm]               | 41  |
| Max pressure [bar]    | 80  |
| Accessories           | N.A.  |
| Notes                 | N.A.  |
| Mounting tips         | N.A.  |

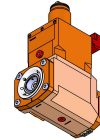

**ATTENTION: CHECK THE ORIENTATION OF THE VDI TEETH**

Always check live tool dimensions on the turret

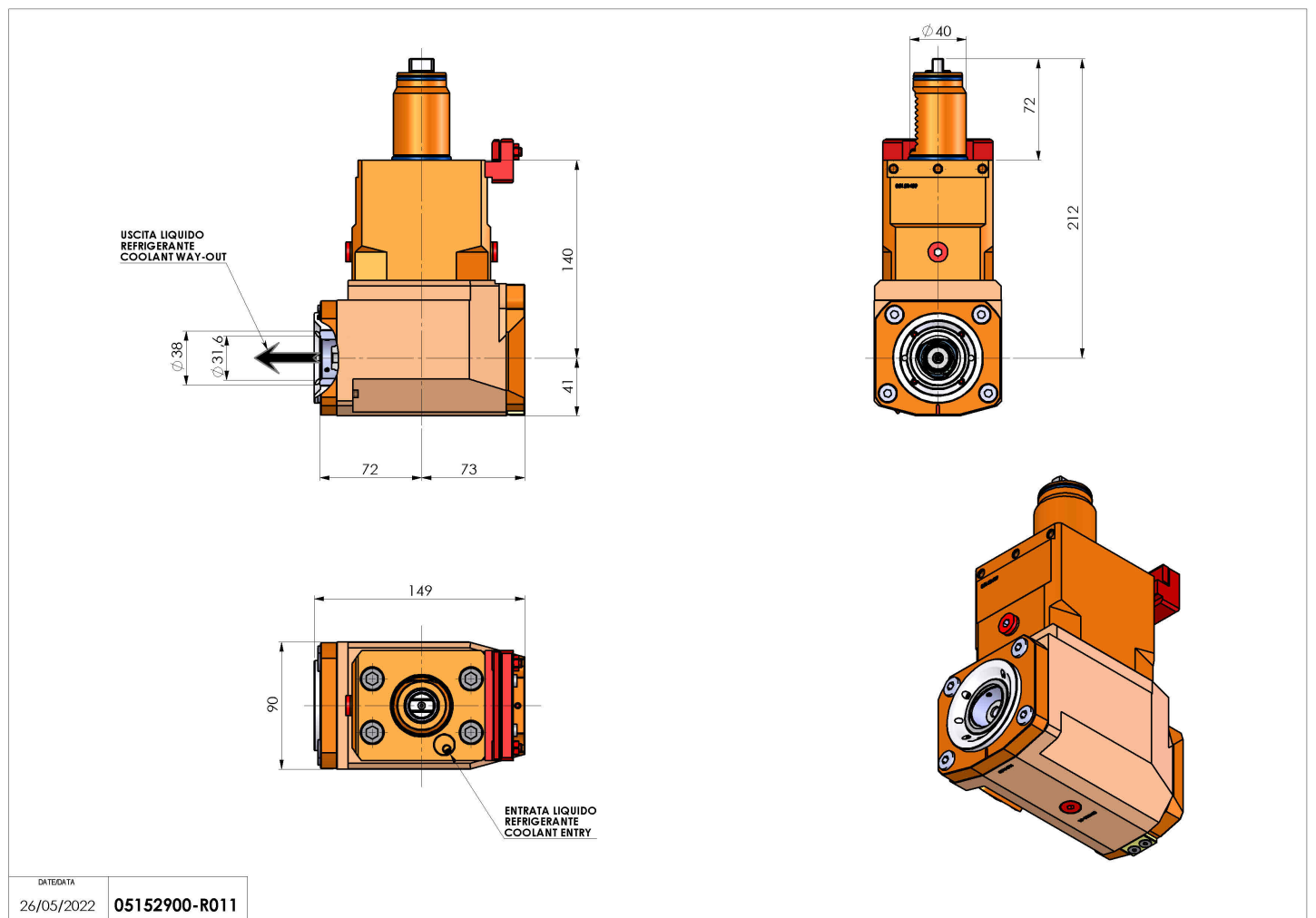

|            |               |
|------------|---------------|
| DATE/DATE  | 05152900-R011 |
| 26/05/2022 |               |

Subject to technical changes