

# 05125900 - LT-A BMT85 ER50 LR H85

Type	LT-A Tool holder angle 90°
Mounting	BMT 85
Tool output	Collet nut ER 50
Coolant	External coolant
Direction of rotation	r1 ↻ r2 ↻
Max speed [rpm]	4000
Max torque [Nm]	180
Ratio	1:1
H [mm]	85
H1 [mm]	52
Accessories	N.A.
Notes	N.A.
Mounting tips	N.A.

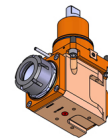

Always check live tool dimensions on the turret

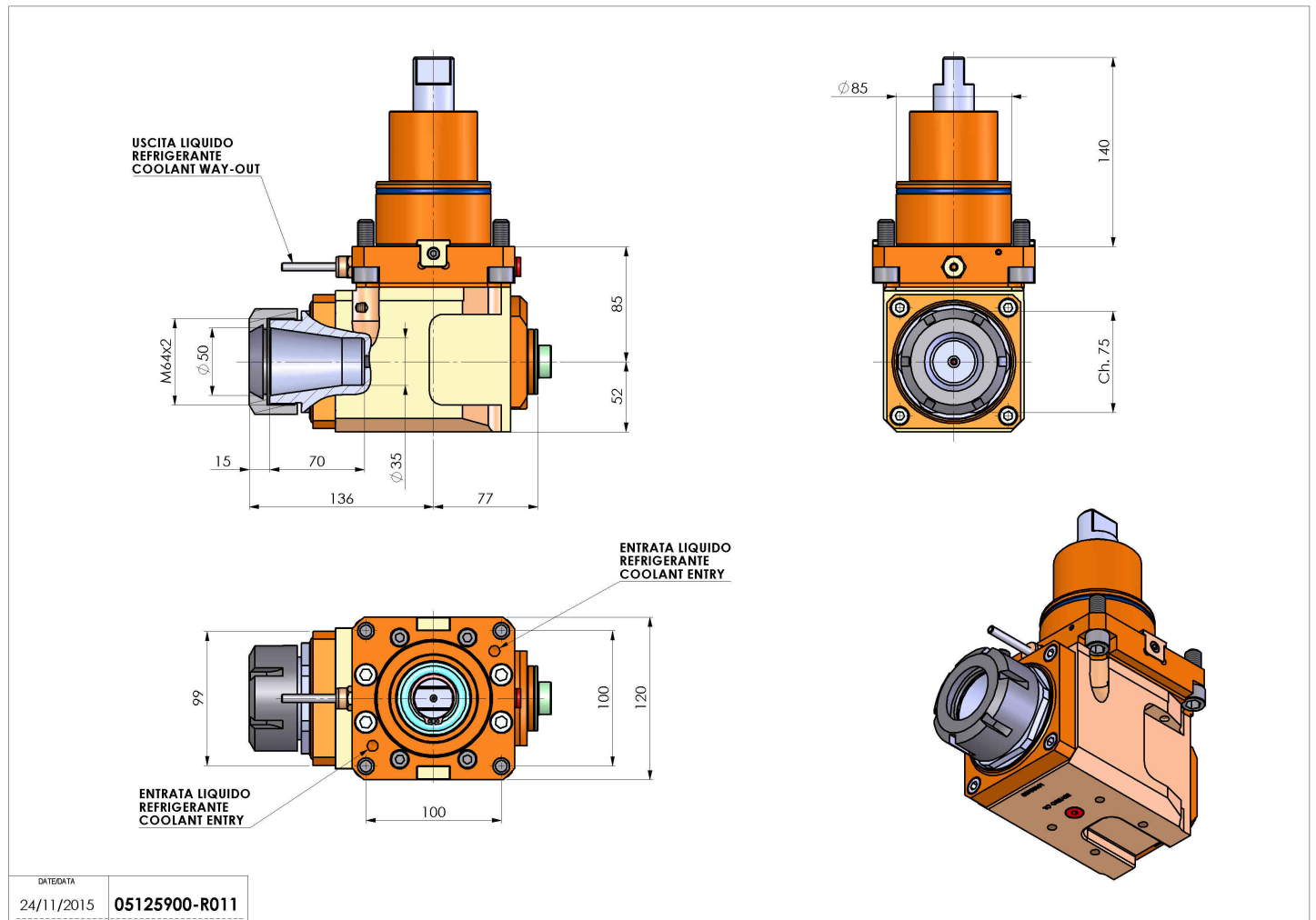

DATE/DATE	05125900-R011
24/11/2015	

Subject to technical changes