

05112200 - LT-S VDI40 DIN22 H81 117 HA

Type	LT-S Tool holder straight
Mounting	VDI 40
Tool output	Shell-Mill DIN138 22
Coolant	External coolant
Direction of rotation	r1 r2
Max speed [rpm]	6000
Max torque [Nm]	63
Ratio	1:1
H [mm]	81
Accessories	
Notes	N.A.
Mounting tips	N.A.

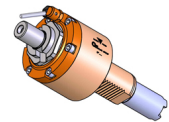

ATTENTION: CHECK THE ORIENTATION OF THE VDI TEETH

Always check live tool dimensions on the turret

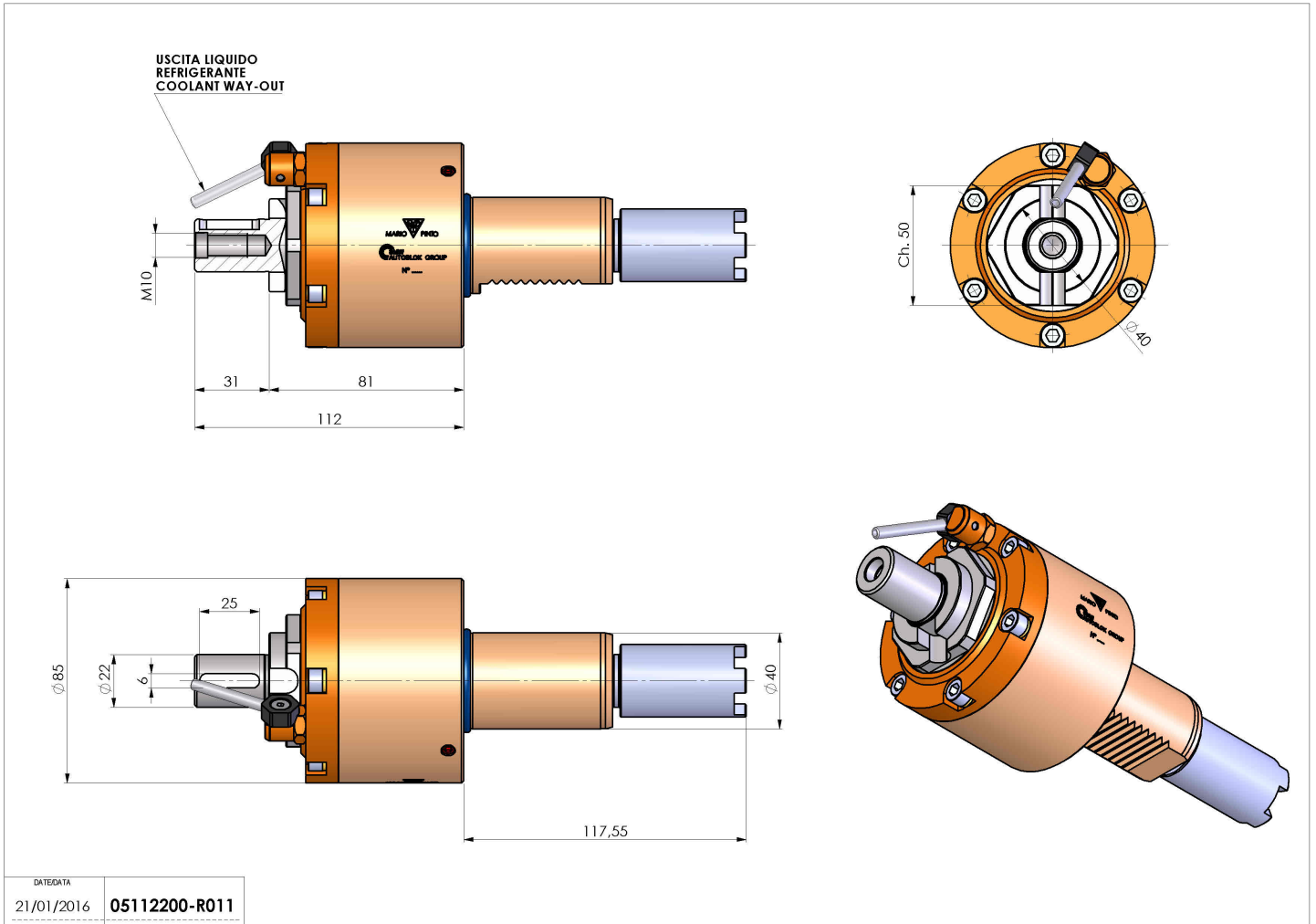

DATE/DATE	21/01/2016
PART NUMBER	05112200-R011

Subject to technical changes