

05112000 - LT-S VDI40 ER32F H74 117 HA

Type	LT-S Tool holder straight
Mounting	VDI 40
Tool output	Collet nut ER 32 F - internal nut
Coolant	External coolant
Direction of rotation	r1 ↻ r2 ↻
Max speed [rpm]	6000
Max torque [Nm]	63
Ratio	1:1
H [mm]	74
Accessories	
Notes	N.A.
Mounting tips	N.A.

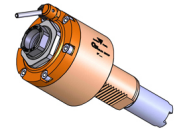

ATTENTION: CHECK THE ORIENTATION OF THE VDI TEETH

Always check live tool dimensions on the turret

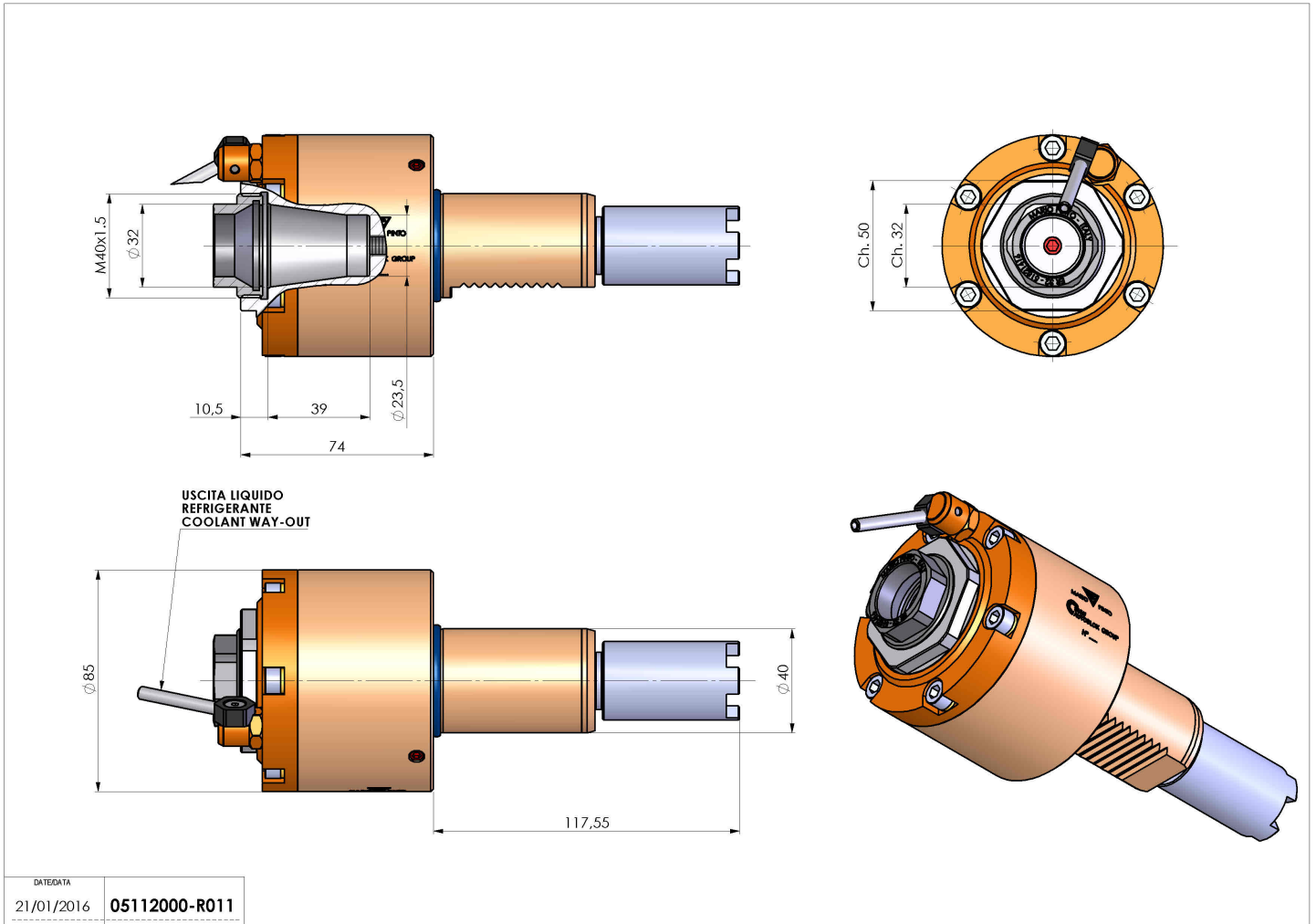

DATE/DATE	05112000-R011
21/01/2016	

Subject to technical changes