



05101200 - LT-A BMT65 ER32F-32F H110 K-W

| | |
|------------------------------|--|
| Type | LT-A DBL Tool holder double angle 90° |
| Mounting | BMT 65 |
| Tool output | Collet nut ER 32 F - internal nut |
| Coolant | External coolant |
| Direction of rotation | r1  r2  r3  |
| Max speed [rpm] | 6000 |
| Max torque [Nm] | 63 |
| Ratio | 1:1 |
| H [mm] | 110 |
| H1 [mm] | 38 |
| Accessories | N.A. |
| Notes | N.A. |
| Mounting tips | N.A. |



Always check live tool dimensions on the turret

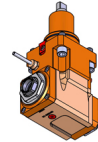
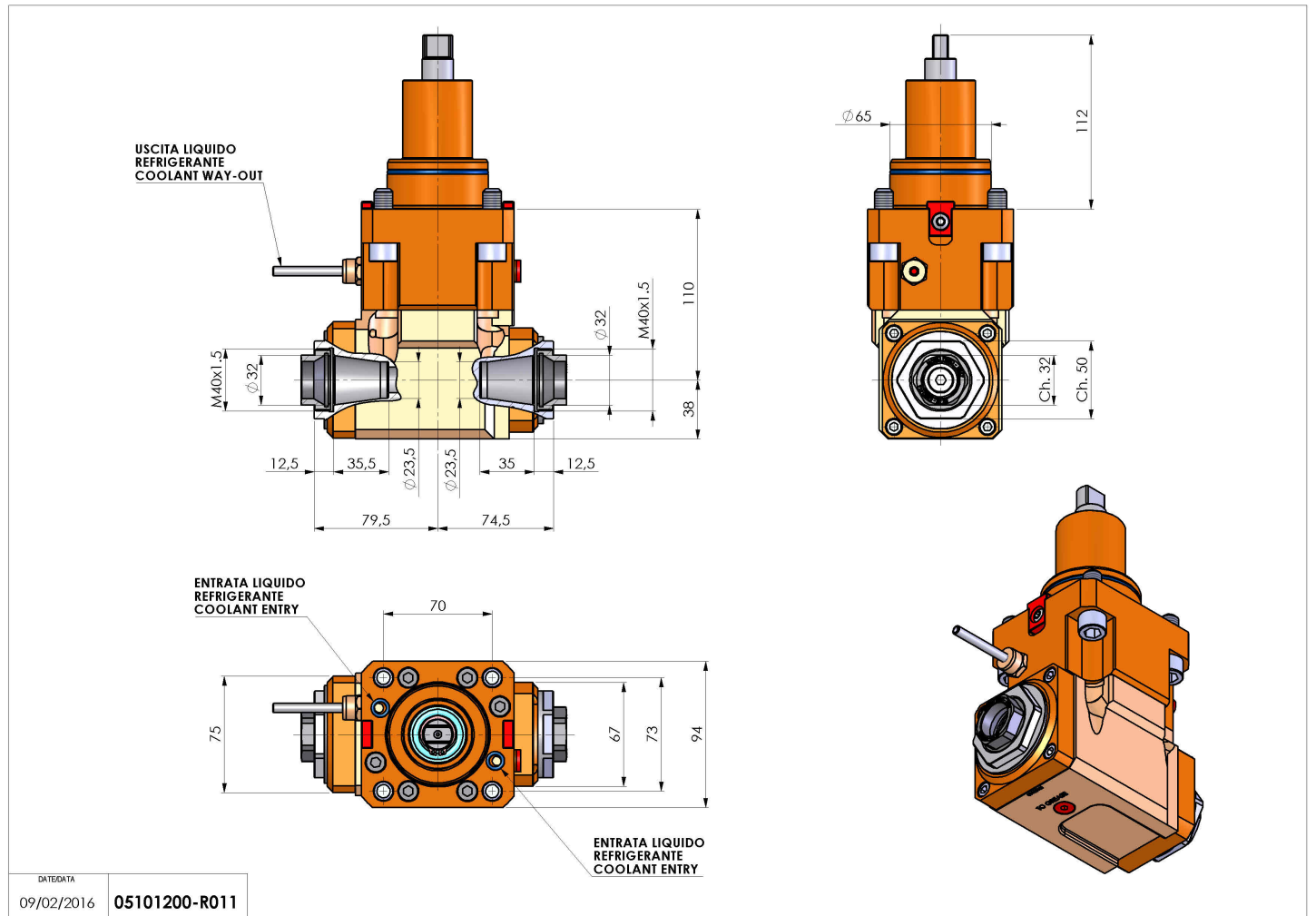

DATE/DATA
09/02/2016 05101200-R011

Subject to technical changes