

05067300 - LT-S2 VDI30 ER11 I25 H85 1:10K

| | |
|------------------------------|--------------------------------------|
| Type | LT-S2 Tool holder double straight |
| Mounting | VDI 30 |
| Tool output | Collet nut ER 11 |
| Coolant | External coolant |
| Direction of rotation | r1 ↻ r2 ↻ r3 ↻ |
| Max speed [rpm] | 6000 |
| Max torque [Nm] | 10 |
| Ratio | 1:1 |
| H [mm] | 85 |
| Accessories | N.A. |
| Notes | N.A. |
| Mounting tips | N.A. |

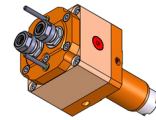

ATTENTION: CHECK THE ORIENTATION OF THE VDI TEETH

Always check live tool dimensions on the turret

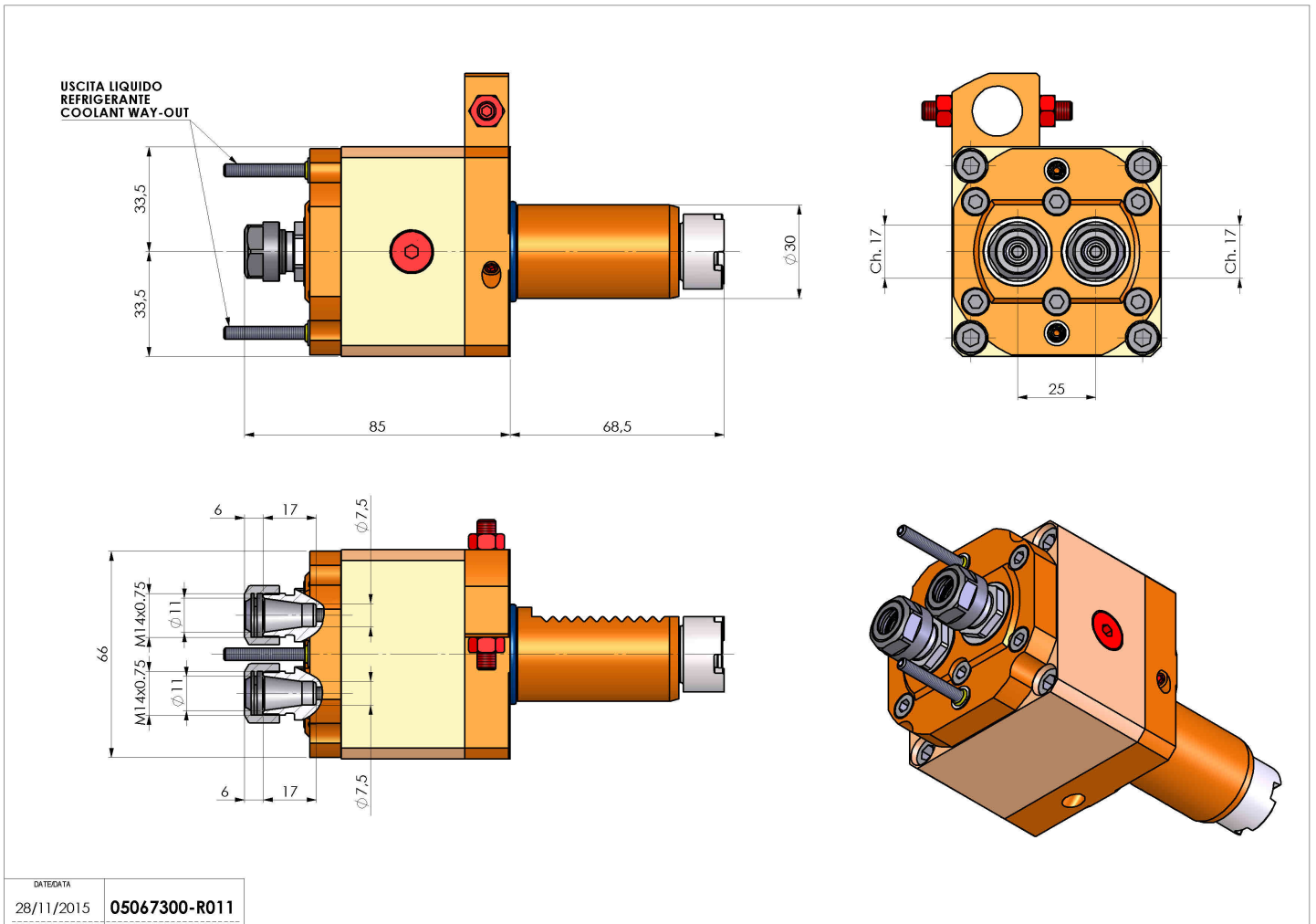

| | |
|------------|---------------|
| DATE/GRA | 05067300-R011 |
| 28/11/2015 | |

Subject to technical changes