

## 05064100 - LT-S VDI30 ER25 H86 OK

Type	LT-S Tool holder straight
Mounting	VDI 30
Tool output	Collet nut ER 25
Coolant	External coolant
Direction of rotation	r1 ↻ r2 ↻
Max speed [rpm]	6000
Max torque [Nm]	40
Ratio	1:1
H [mm]	86
Accessories	
Notes	N.A.
Mounting tips	N.A.

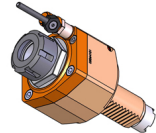

**ATTENTION: CHECK THE ORIENTATION OF THE VDI TEETH**

Always check live tool dimensions on the turret

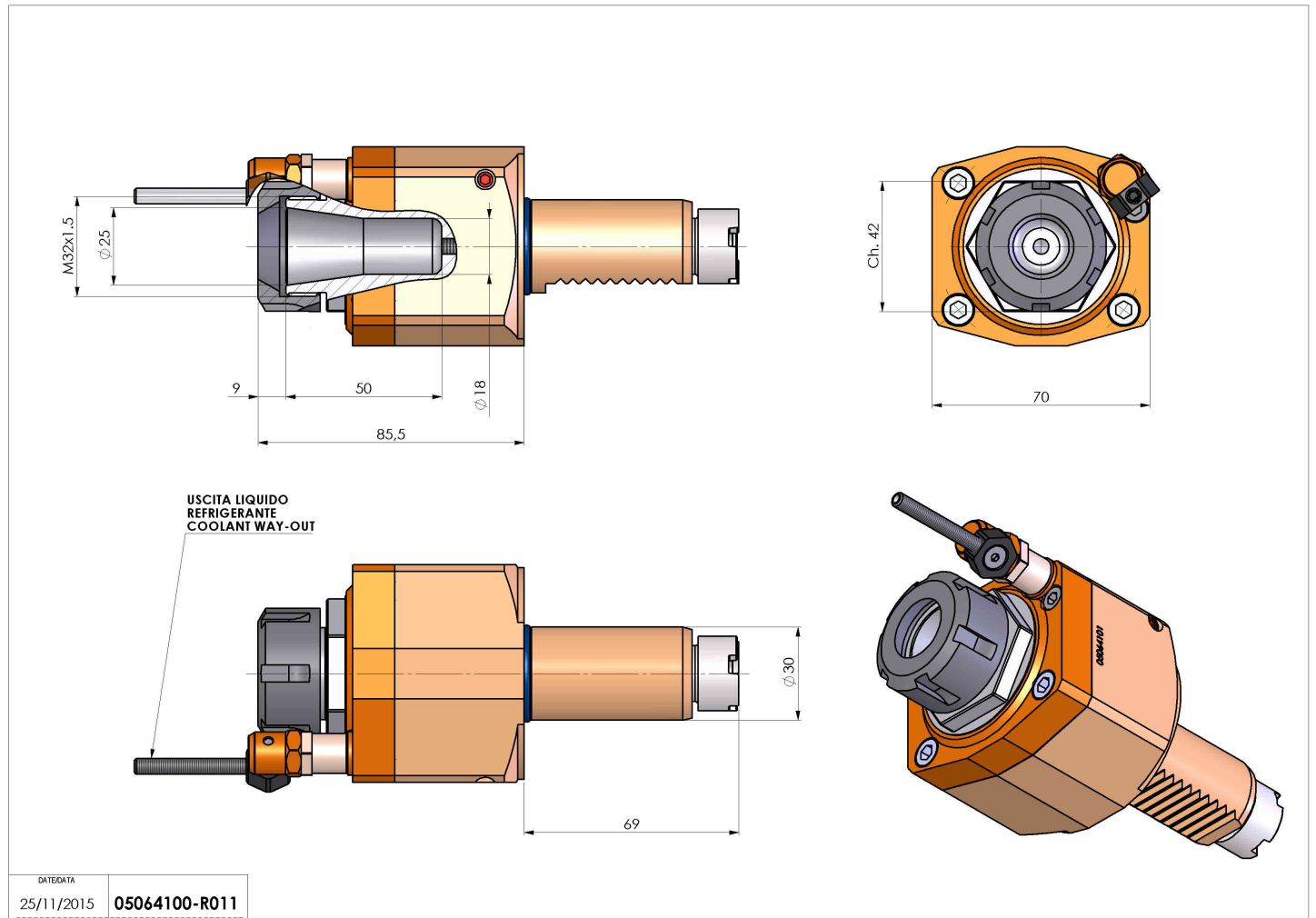

Subject to technical changes