



05046800 - LT-S D60 HSK40 RF H97

Type	LT-S Tool holder straight
Mounting	CYLINDRICAL SHANK 60
Tool output	Quick Change HSK40
Coolant	Internal coolant
Direction of rotation	r1  r2 
Max speed [rpm]	6000
Max torque [Nm]	63
Ratio	1:1
H [mm]	97
Max pressure [bar]	20
Accessories	
Notes	N.A.
Mounting tips	N.A.



Always check live tool dimensions on the turret

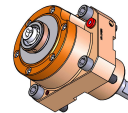
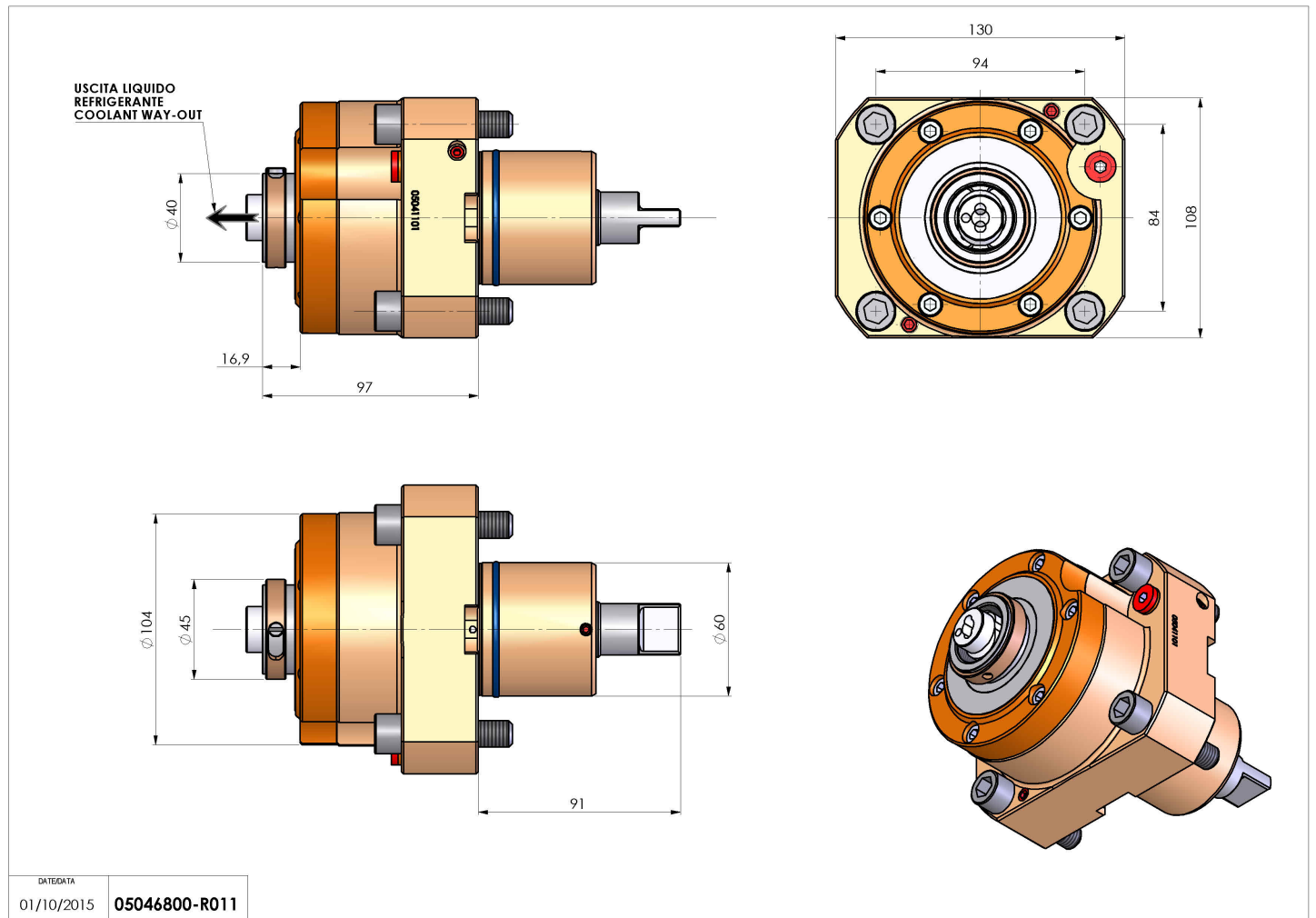

Subject to technical changes