

05034900 - LT-A D60 ER40F HRF H90

Type	LT-A Tool holder angle 90°
Mounting	CYLINDRICAL SHANK 60
Tool output	Collet nut ER 40 F - internal nut
Coolant	HRF Internal coolant
Direction of rotation	r1 r2
Max speed [rpm]	5000
Max torque [Nm]	90
Ratio	1:1
H [mm]	90
H1 [mm]	43
Max pressure [bar]	80
Accessories	N.A.
Notes	N.A.
Mounting tips	N.A.

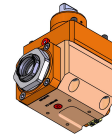

Always check live tool dimensions on the turret

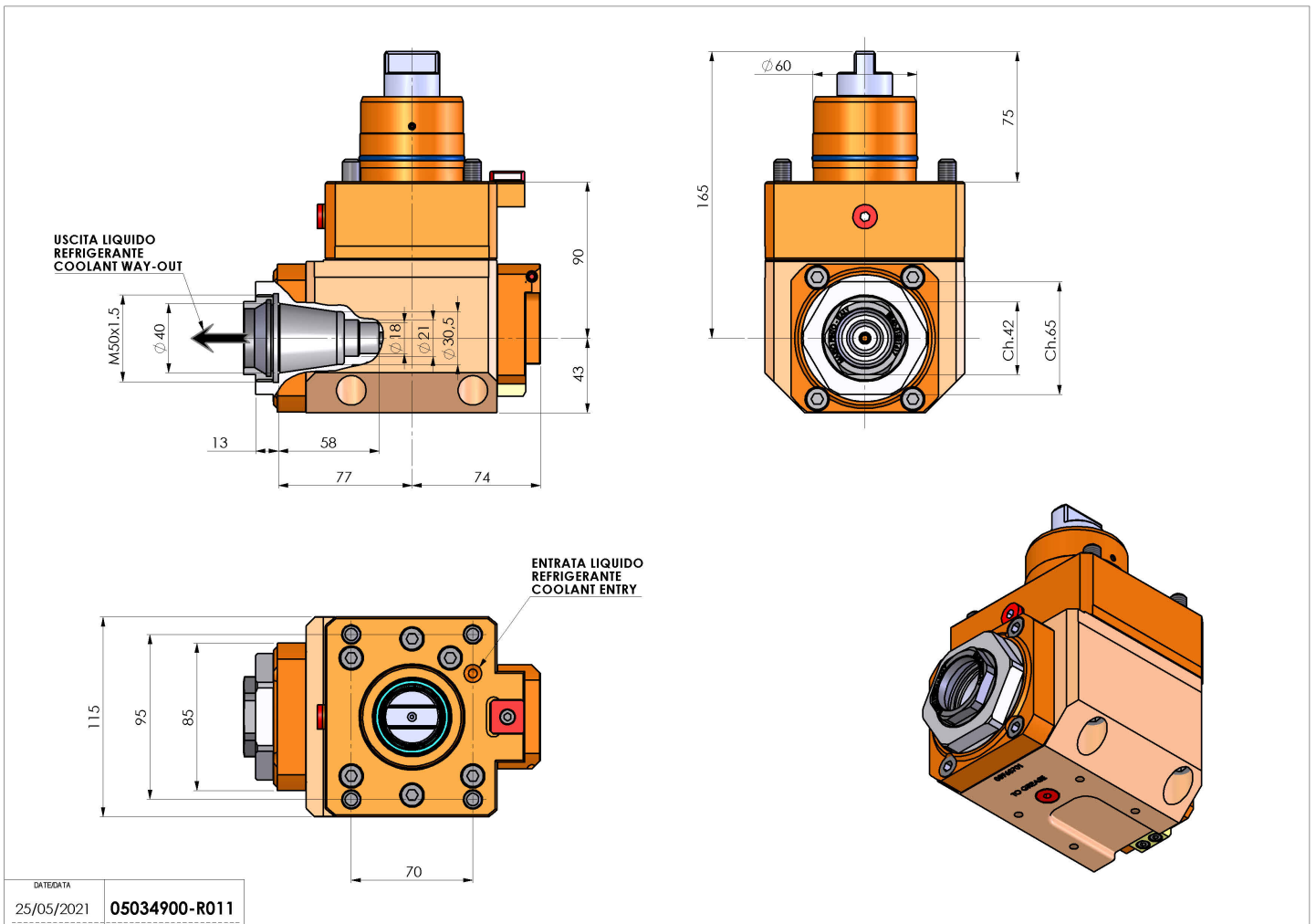

Subject to technical changes