

05034800 - LT-S D60 ER40F RF H90

Type	LT-S Tool holder straight
Mounting	CYLINDRICAL SHANK 60
Tool output	Collet nut ER 40 F - internal nut
Coolant	Internal coolant
Direction of rotation	r1 ↻ r2 ↻
Max speed [rpm]	5000
Max torque [Nm]	90
Ratio	1:1
H [mm]	90
Max pressure [bar]	20
Accessories	N.A.
Notes	N.A.
Mounting tips	N.A.

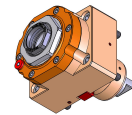

Always check live tool dimensions on the turret

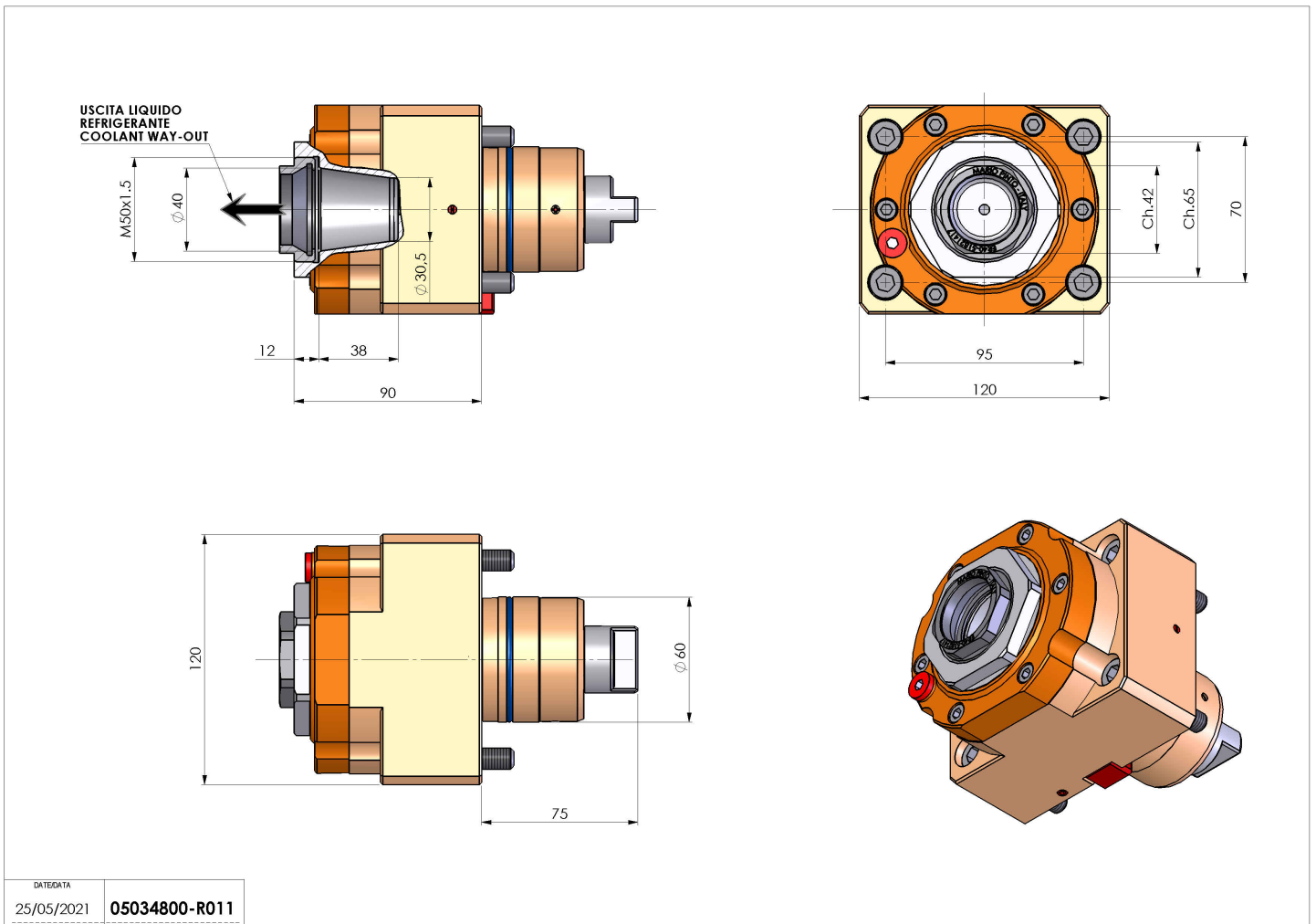

DATE/DATE	05034800-R011
25/05/2021	

Subject to technical changes