



05018400 - LT-A D44 ER25F L-R RF H75 NK

Type	LT-A Tool holder angle 90°
Mounting	CYLINDRICAL SHANK 44
Tool output	Collet nut ER 25 F - internal nut
Coolant	Internal coolant
Direction of rotation	r1  r2 
Max speed [rpm]	6000
Max torque [Nm]	30
Ratio	1:1
H [mm]	75
H1 [mm]	32,5
Max pressure [bar]	20
Accessories	N.A.
Notes	N.A.
Mounting tips	N.A.



Always check live tool dimensions on the turret

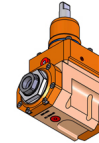
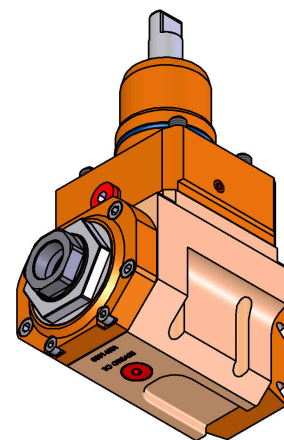
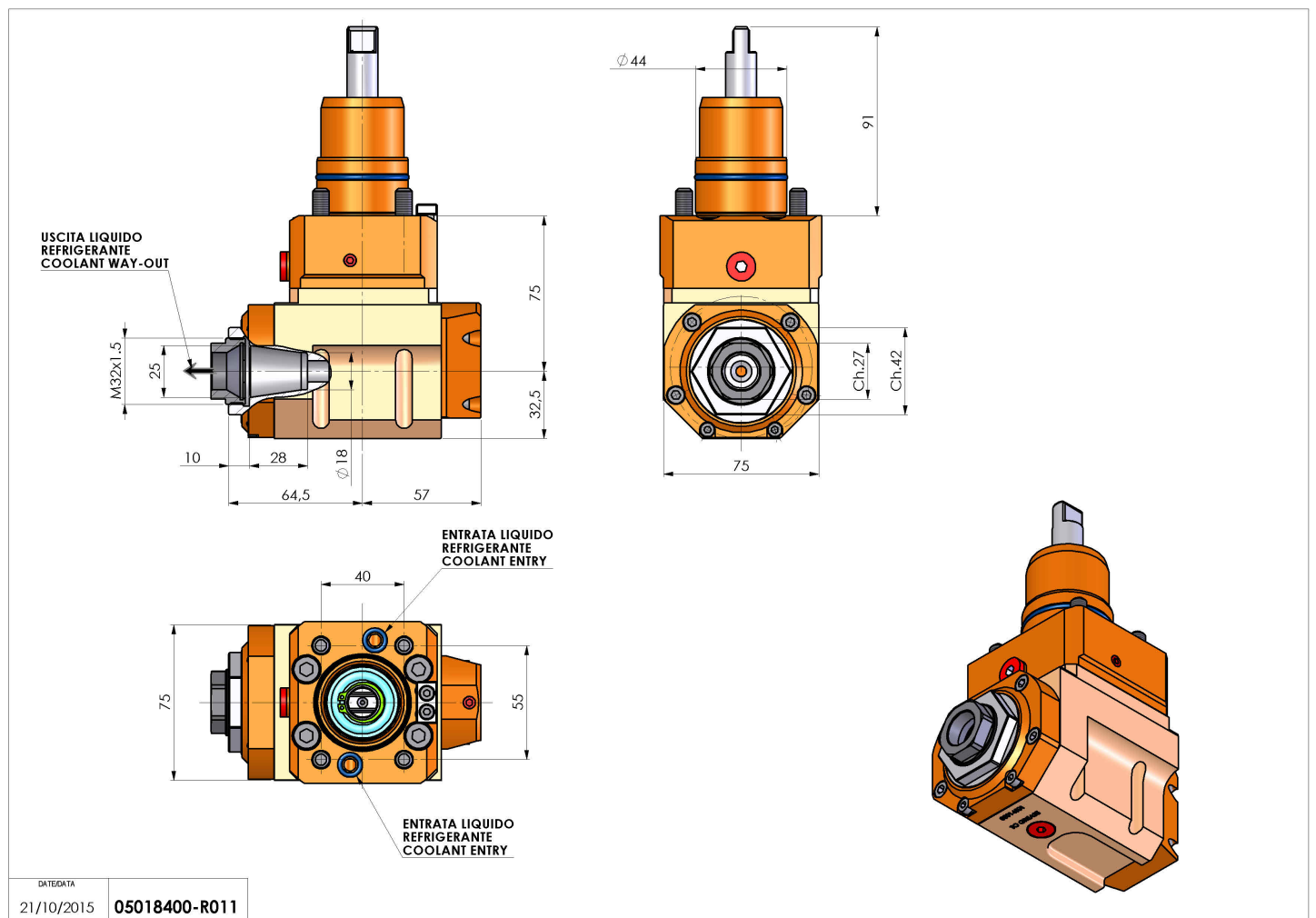

Subject to technical changes