

# 05015300 - LT-A D55 ER32F H65 NK

<b>Type</b>	LT-A Tool holder angle 90°
<b>Mounting</b>	CYLINDRICAL SHANK 55
<b>Tool output</b>	Collet nut ER 32 F - internal nut
<b>Coolant</b>	External coolant
<b>Direction of rotation</b>	r1 ↻ r2 ↻
<b>Max speed [rpm]</b>	6000
<b>Max torque [Nm]</b>	63
<b>Ratio</b>	1:1
<b>H [mm]</b>	65
<b>H1 [mm]</b>	36
<b>Accessories</b>	N.A.
<b>Notes</b>	N.A.
<b>Mounting tips</b>	N.A.

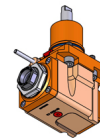

Always check live tool dimensions on the turret

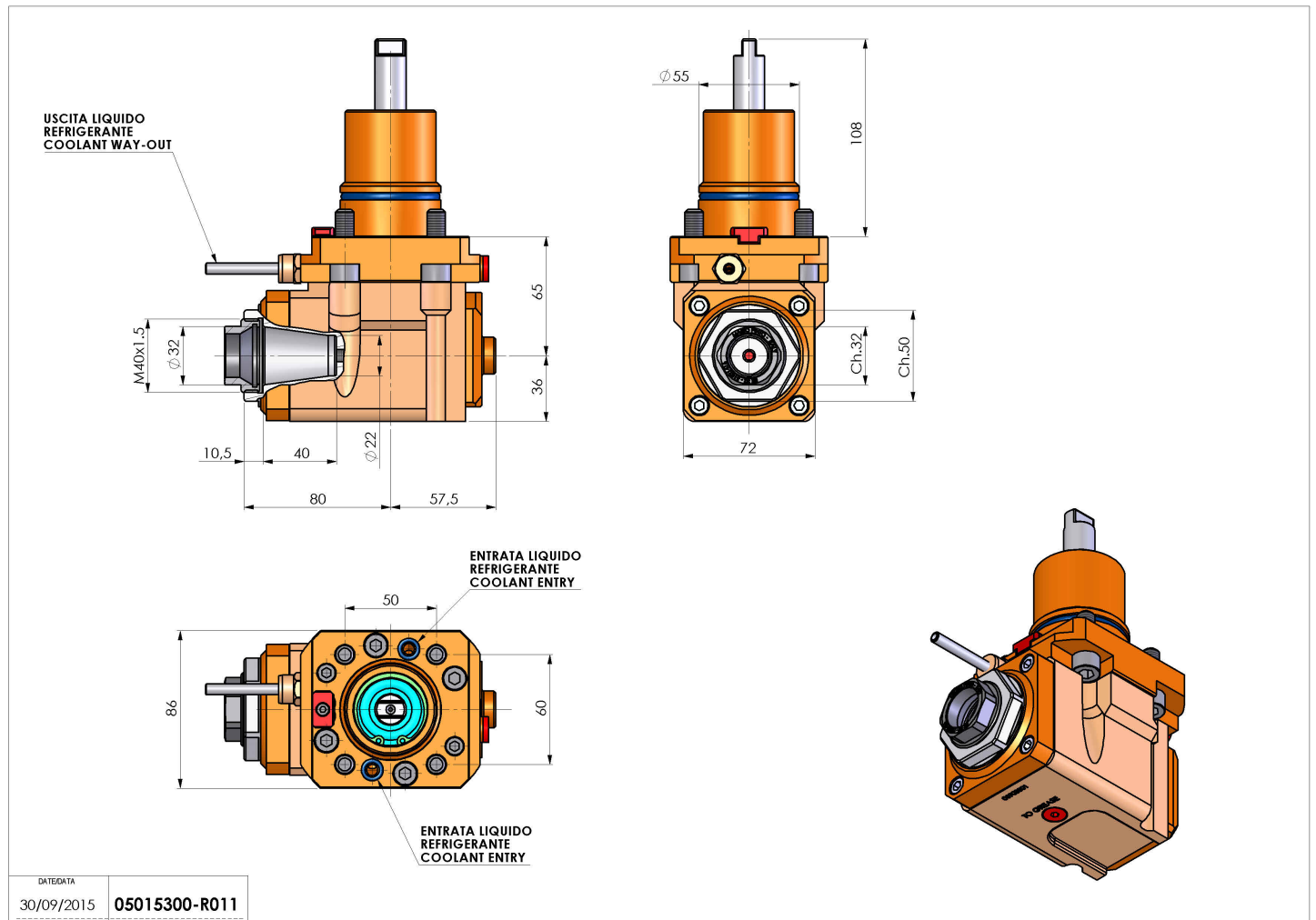

Subject to technical changes