

05014900 - LT-S D44 ER25 H64 NK

Type	LT-S Tool holder straight
Mounting	CYLINDRICAL SHANK 44
Tool output	Collet nut ER 25
Coolant	External coolant
Direction of rotation	r1  r2 
Max speed [rpm]	6000
Max torque [Nm]	40
Ratio	1:1
H [mm]	64
Accessories	
Notes	N.A.
Mounting tips	N.A.

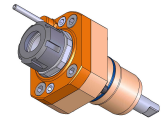

Always check live tool dimensions on the turret

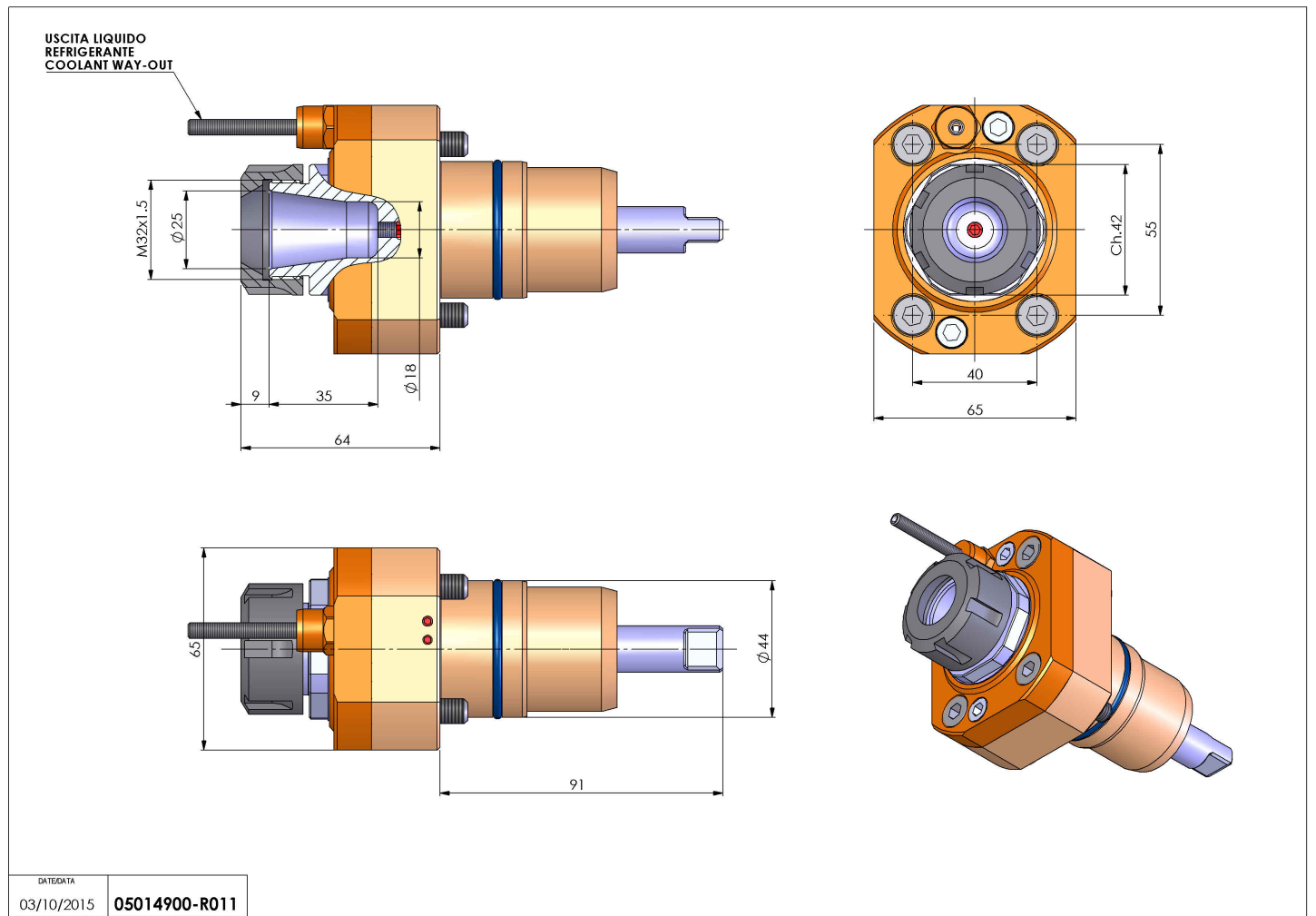

Subject to technical changes