



05013300 - LT-S D55 ER32 HRF HS H93

Type	LT-S Tool holder straight
Mounting	CYLINDRICAL SHANK 55
Tool output	Collet nut ER 32
Coolant	HRF Internal/external coolant
Direction of rotation	r1  r2 
Max speed [rpm]	10000
Max torque [Nm]	40
Ratio	1:1
H [mm]	93
Max pressure [bar]	70
Accessories	N.A.
Notes	N.A.
Mounting tips	N.A.



Always check live tool dimensions on the turret

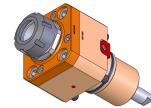
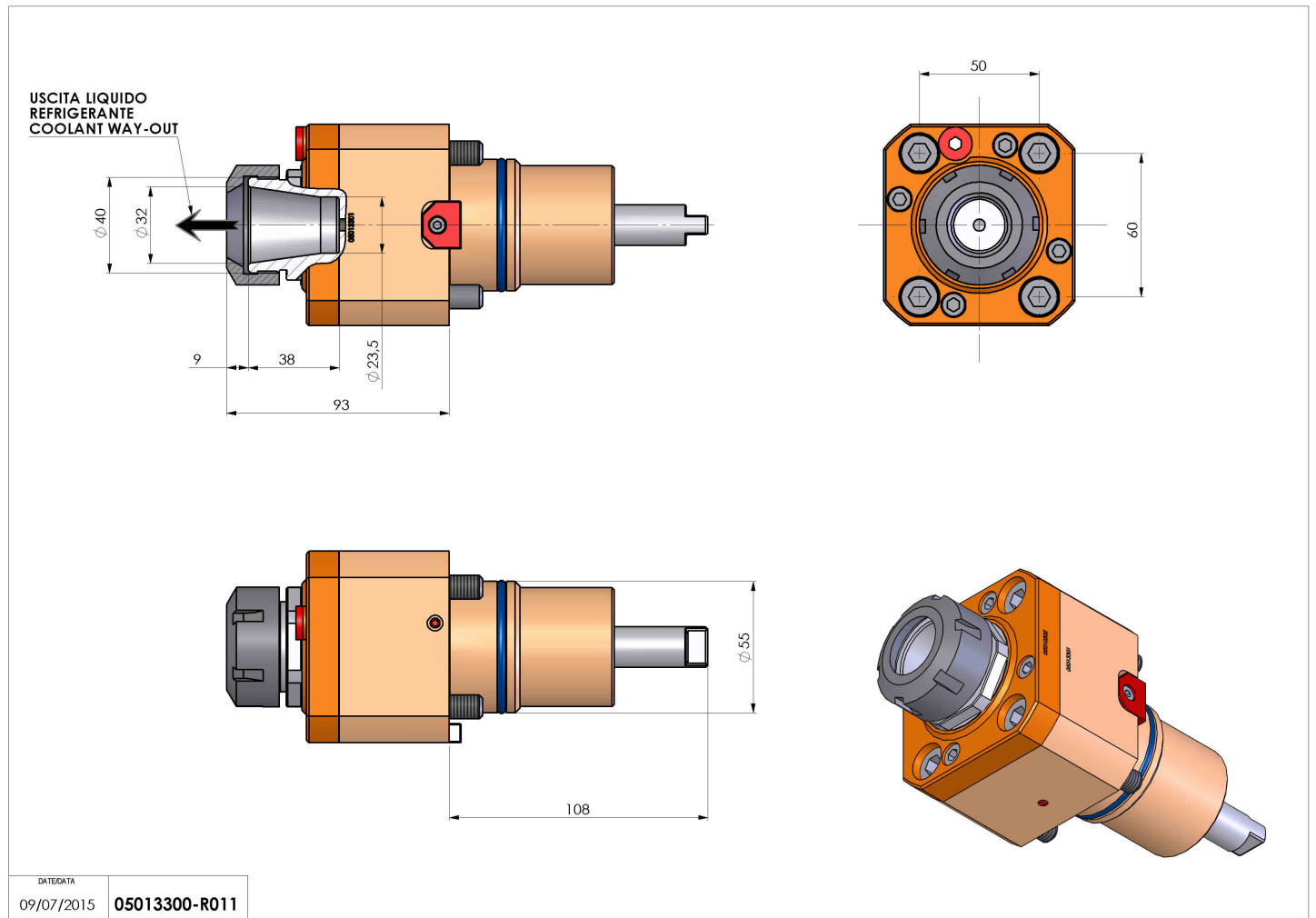

Subject to technical changes