



05011300 - LT-S D55 ER32F H52 NK

Type	LT-S Tool holder straight
Mounting	CYLINDRICAL SHANK 55
Tool output	Collet nut ER 32 F - internal nut
Coolant	External coolant
Direction of rotation	r1  r2 
Max speed [rpm]	6000
Max torque [Nm]	63
Ratio	1:1
H [mm]	52
Accessories	
Notes	N.A.
Mounting tips	N.A.



Always check live tool dimensions on the turret

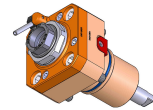
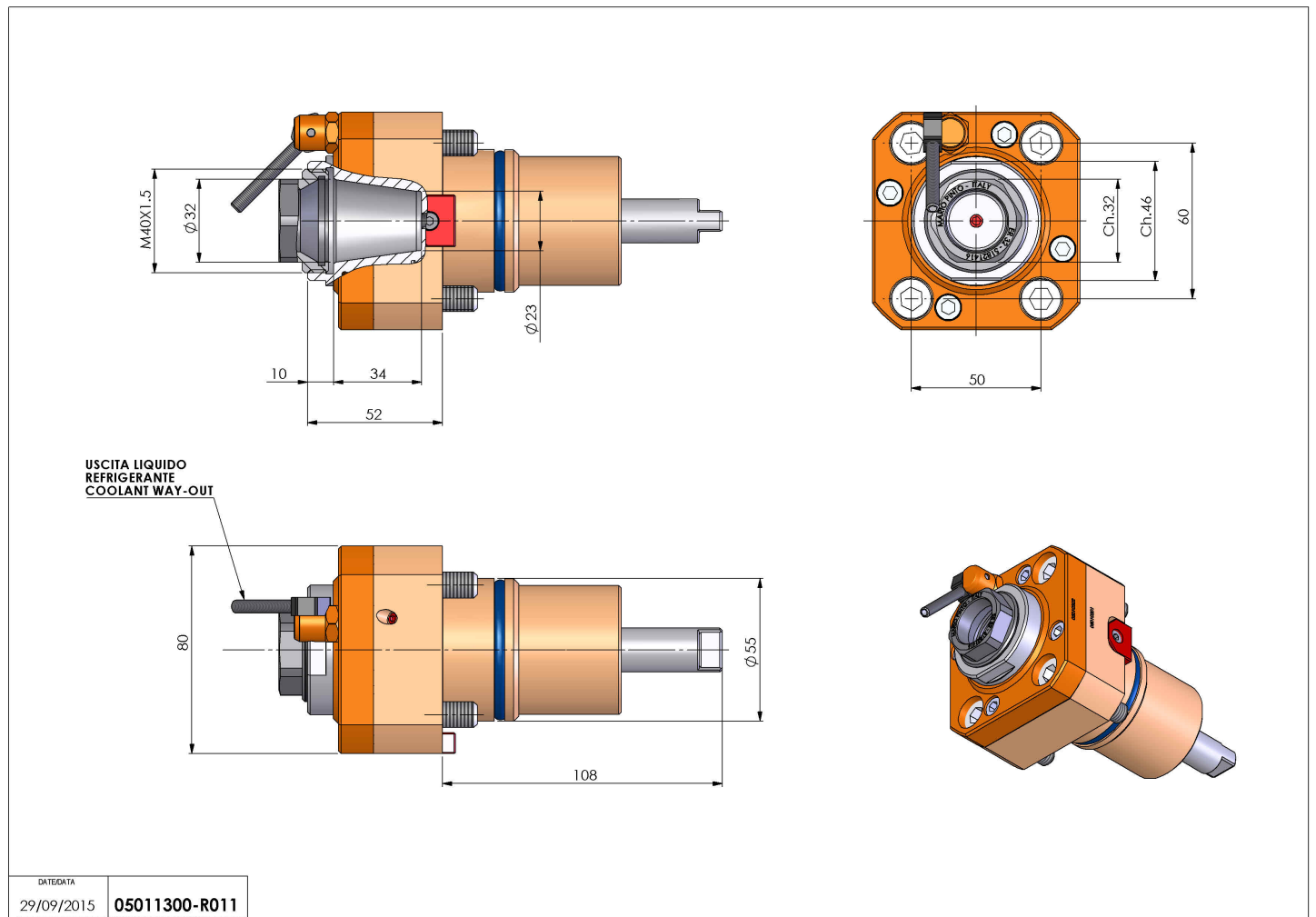

DATE/DATE
29/09/2015 05011300-R011

Subject to technical changes