

06380100 - TH-RAD D65 Q25 H65

Type	TH-RAD Radial Tool holder
Mounting	CYLINDRICAL SHANK 65
Tool output	Radial Square Tool Holder 25x25
Coolant	External coolant
H [mm]	65

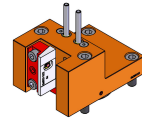

Accessories	N.A.
Notes	N.A.
Mounting tips	N.A.

Always check live tool dimensions on the turret

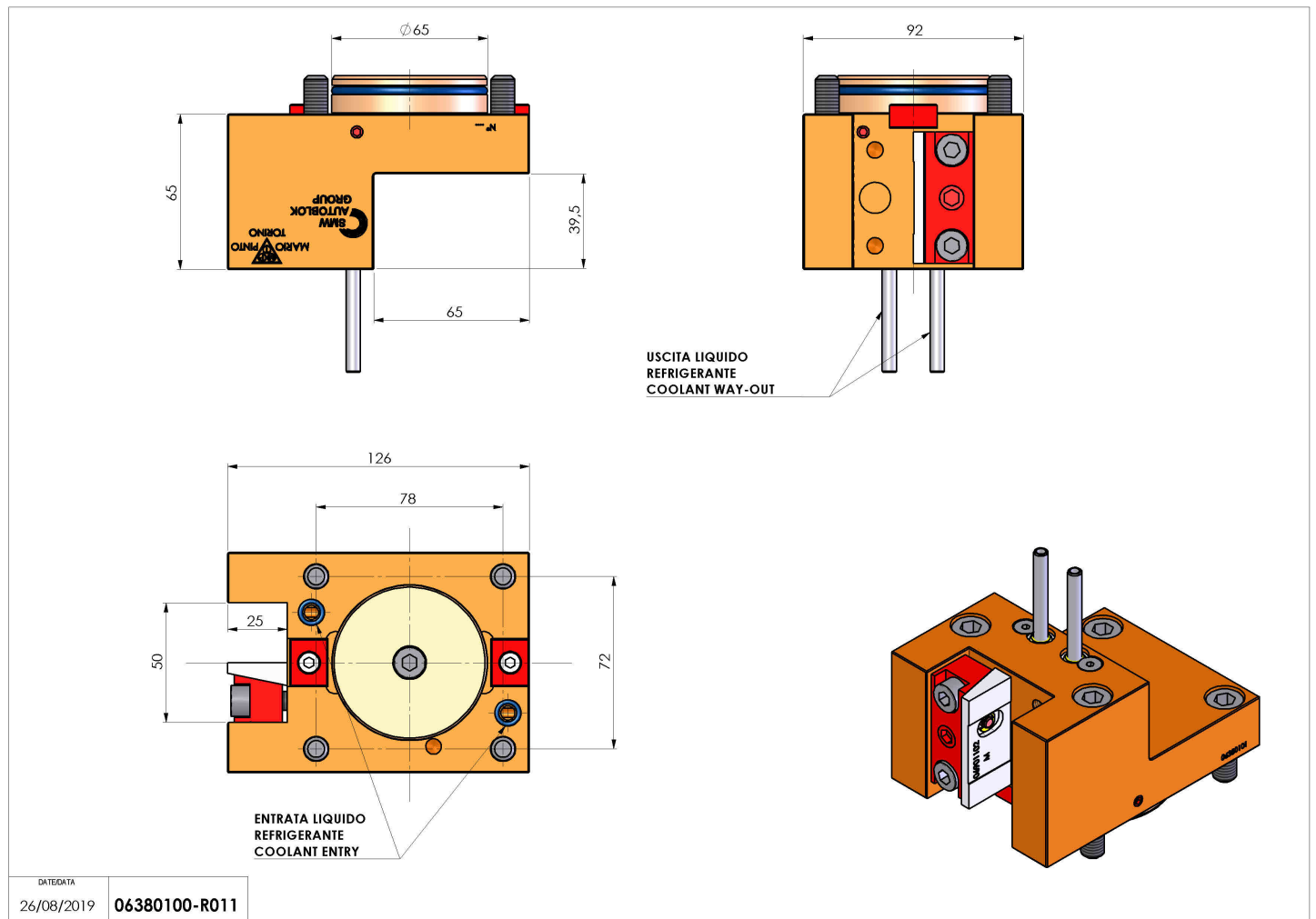

Subject to technical changes