

06306700 - TH-AX BMT75 C63 RF H90

Type	TH-AX Axial Tool holder
Mounting	BMT 75
Tool output	Polygonal shank C63 ISO 26623-1
Coolant	Internal coolant
H [mm]	90

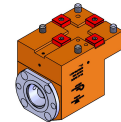

Accessories	N.A.
Notes	N.A.
Mounting tips	N.A.

Always check live tool dimensions on the turret

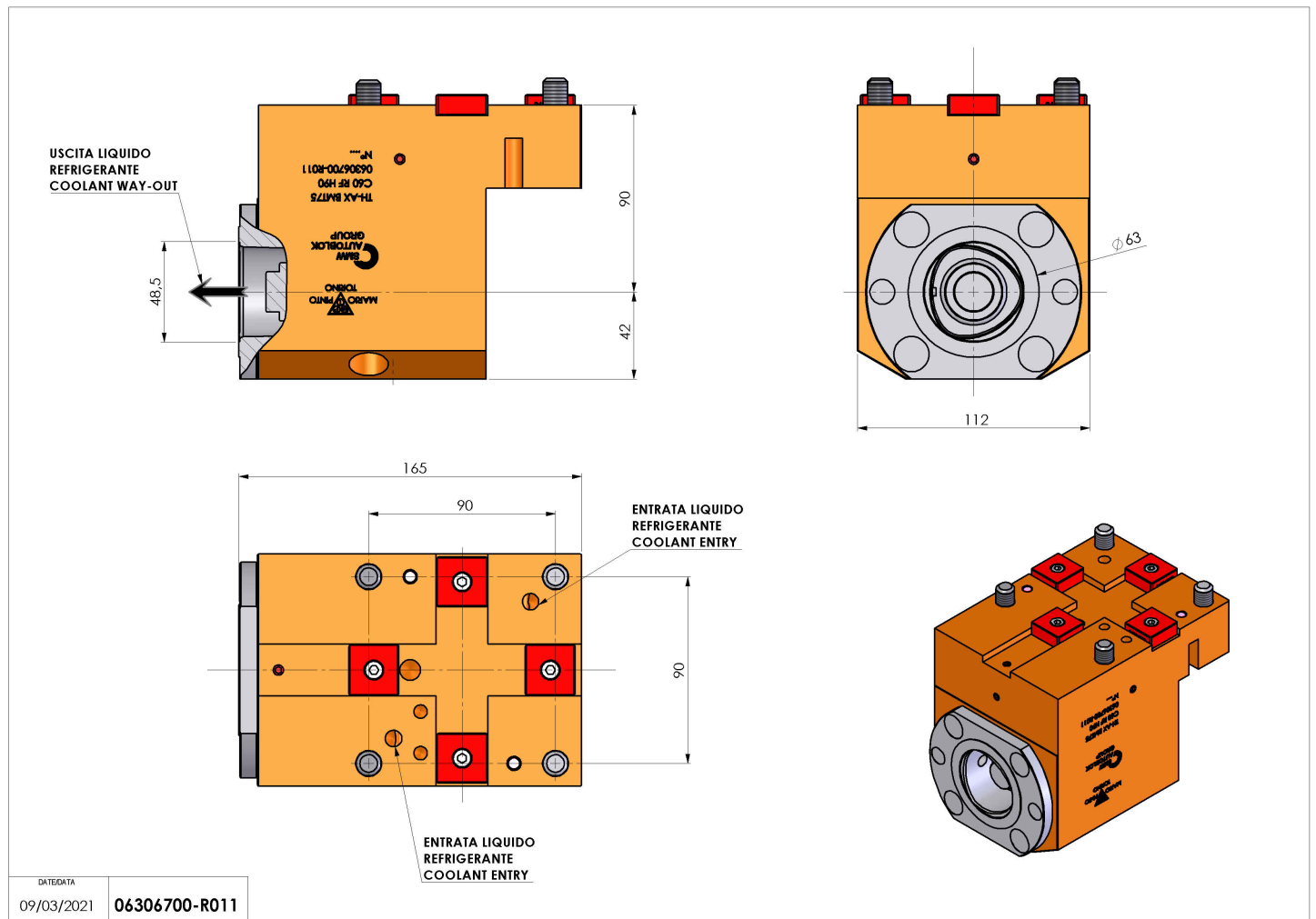

Subject to technical changes