

06304300 - TH-RAD BMT65 1"X1" H75

Type	TH-RAD Radial Tool holder
Mounting	BMT 65
Tool output	Radial Square Tool Holder 1"x1"
Coolant	External coolant
H [mm]	75
Accessories	N.A.
Notes	N.A.
Mounting tips	N.A.

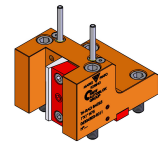

Always check live tool dimensions on the turret

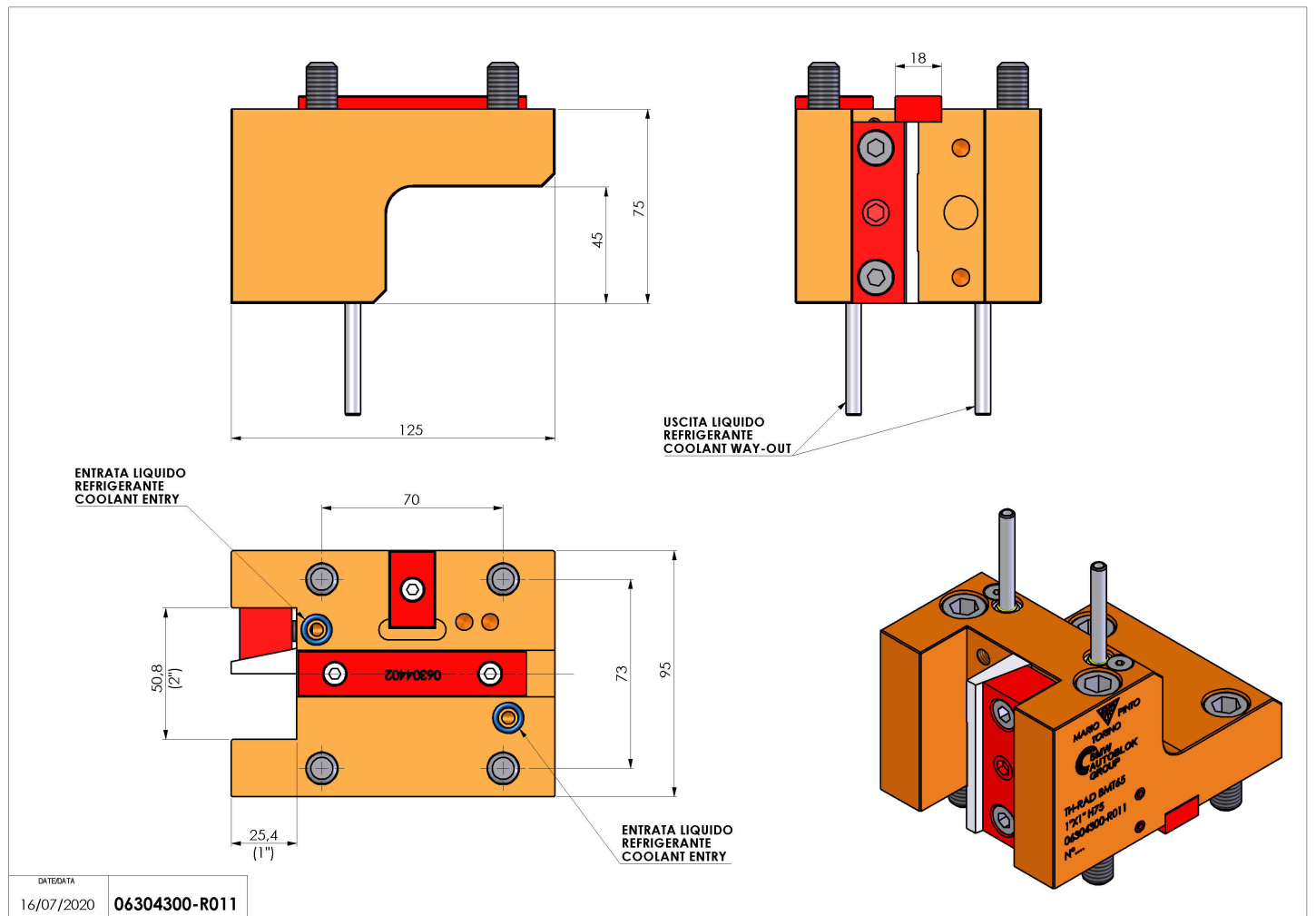

DATE/DATE	16/07/2020
06304300-R011	

Subject to technical changes