

06304200 - TH-RAD BMT65 25X25 H75

Type	TH-RAD Radial Tool holder
Mounting	BMT 65
Tool output	Radial Square Tool Holder 25x25
Coolant	External coolant
H [mm]	75

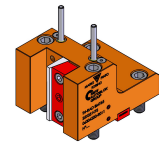

Accessories	N.A.
Notes	N.A.
Mounting tips	N.A.

Always check live tool dimensions on the turret

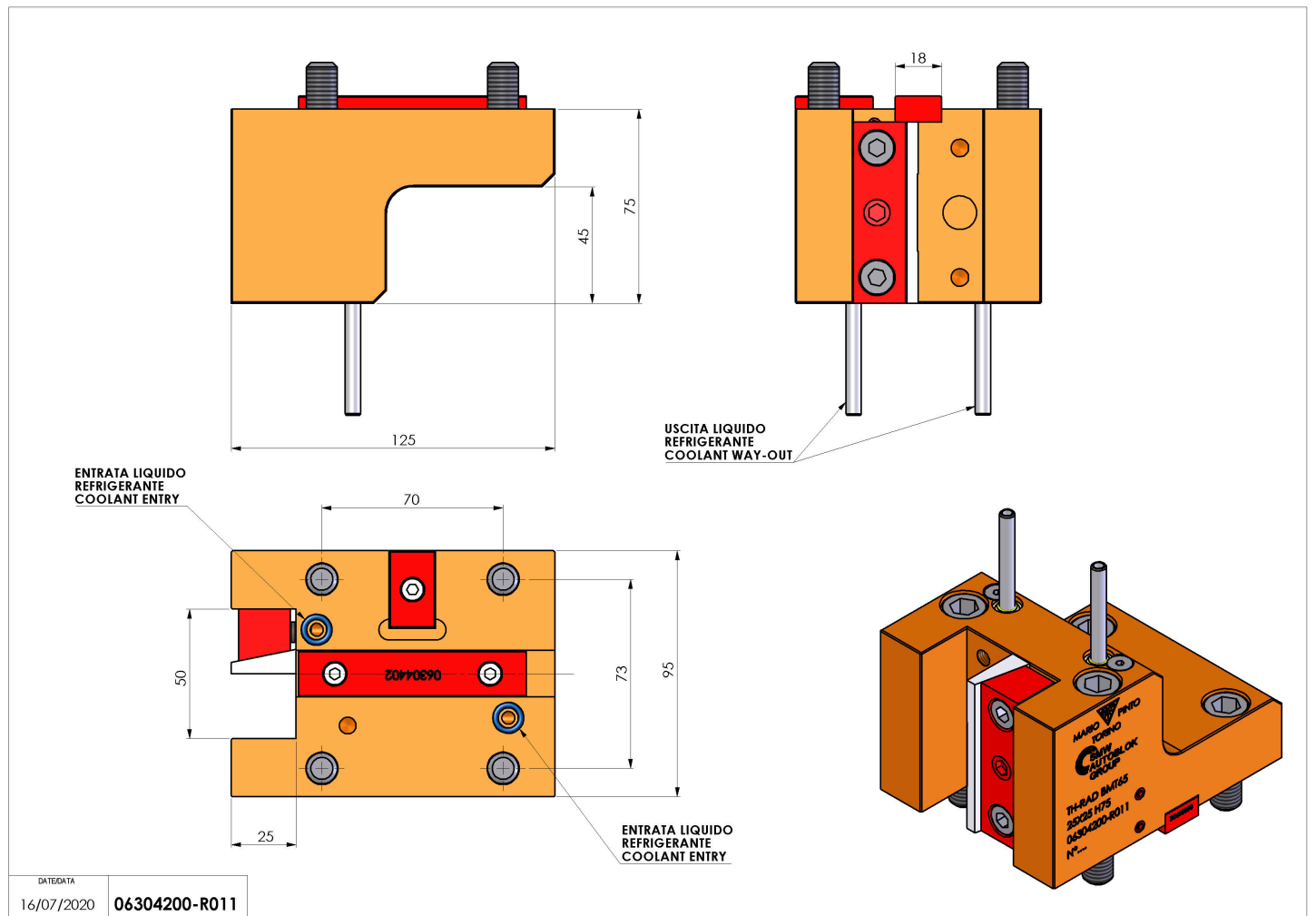

Subject to technical changes