

06300900 - TH-AX BMT45 C40 RF H70

Type	TH-AX Axial Tool holder
Mounting	BMT 45
Tool output	Polygonal shank C40 ISO 26623-1
Coolant	Internal coolant
H [mm]	70
Accessories	N.A.
Notes	N.A.
Mounting tips	N.A.

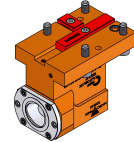

Always check live tool dimensions on the turret

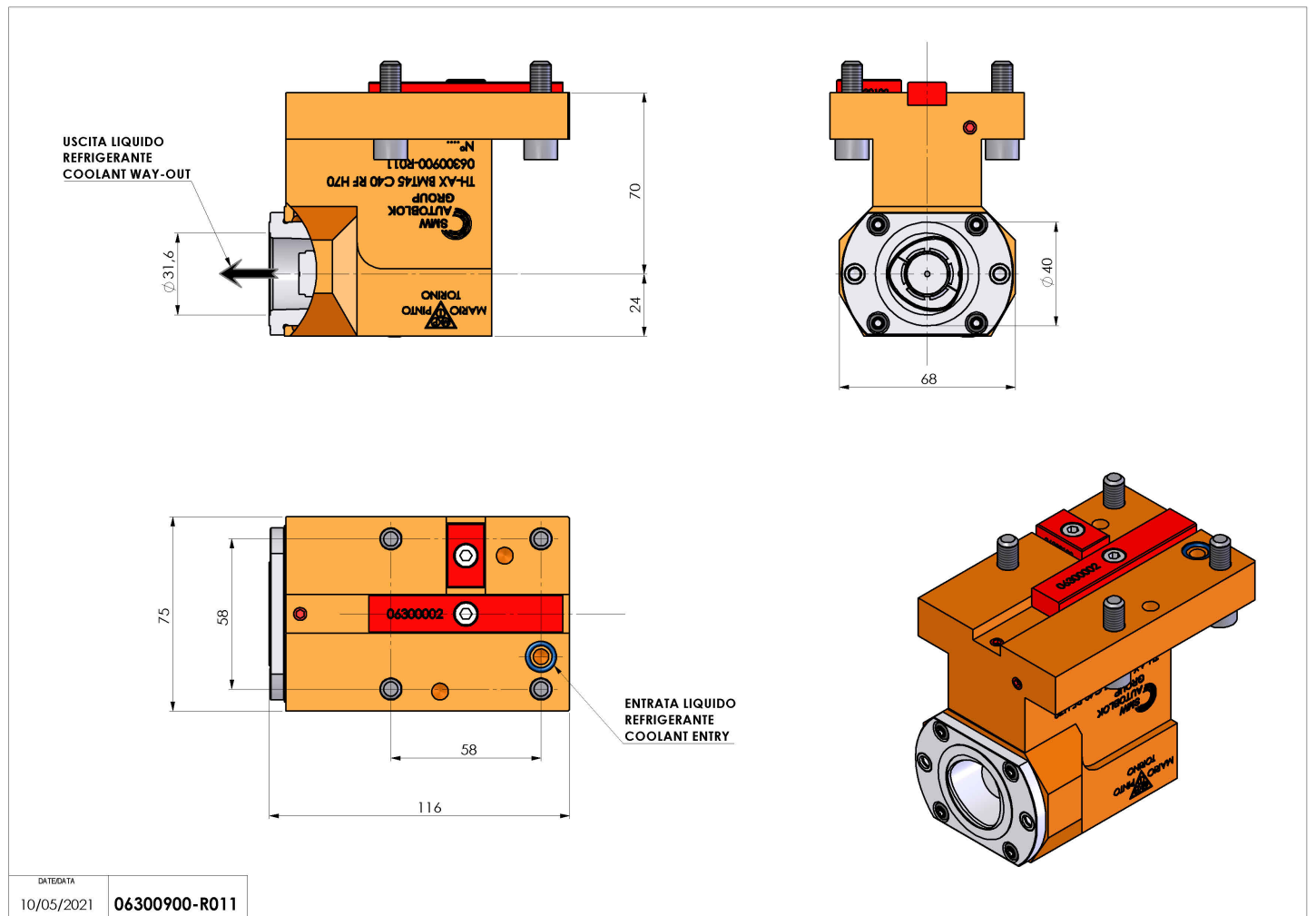

DATE/DATE	10/05/2021
	06300900-R011

Subject to technical changes