

06258500 - TH-BRB D68 D40 H90

Type	TH-BRB Boring bar holder
Mounting	CYLINDRICAL SHANK 68
Tool output	Boring Bar Holder 40
Coolant	External / Internal coolant
H [mm]	90

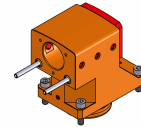

Accessories	N.A.
Notes	N.A.
Mounting tips	N.A.

Always check live tool dimensions on the turret

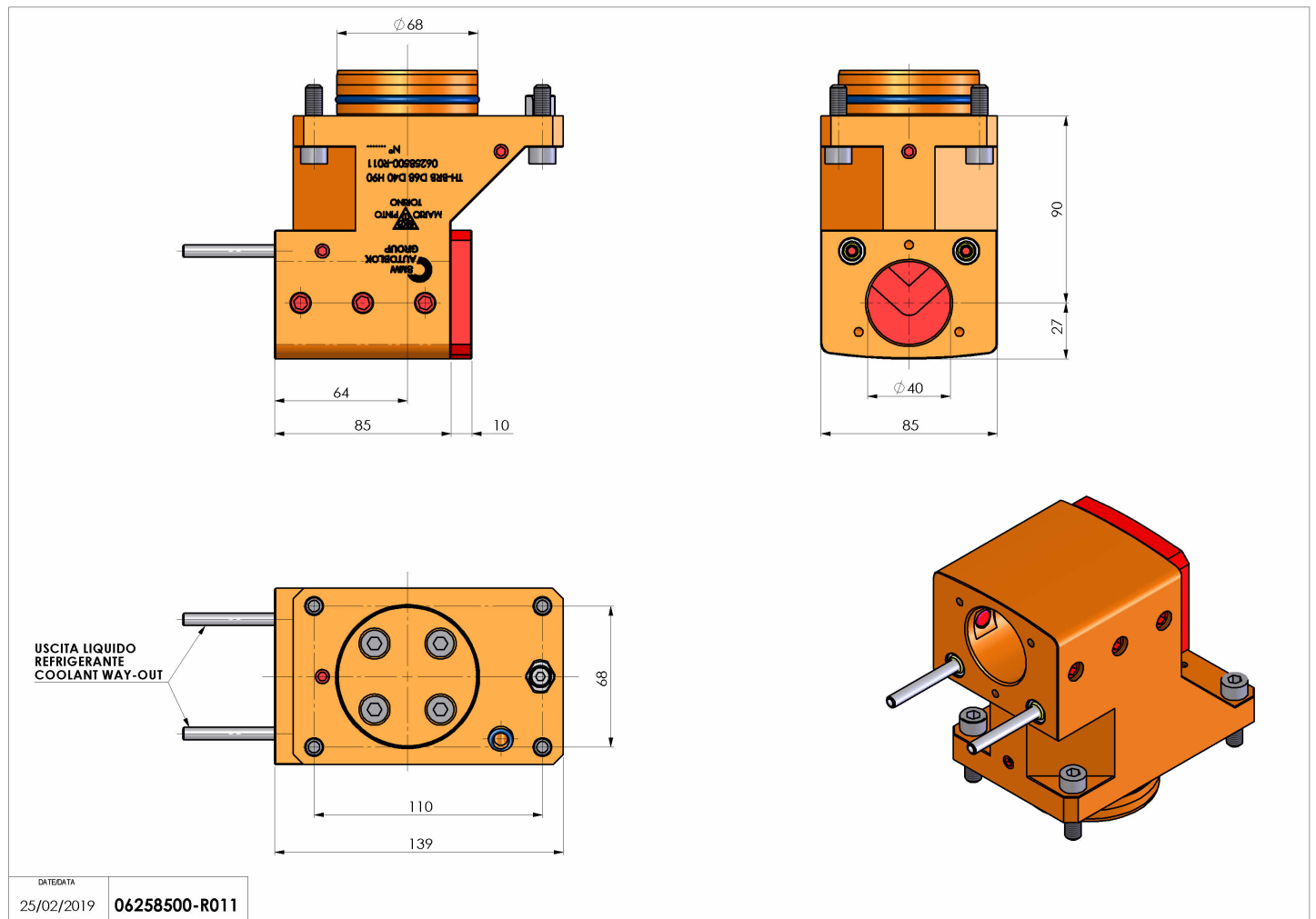

DATE/DATE	25/02/2019
	06258500-R011

Subject to technical changes