

## 06256000 - TH-BRB D80 D50 H120 MZ

Type	TH-BRB Boring bar holder
Mounting	CYLINDRICAL SHANK 80
Tool output	Boring Bar Holder 50
Coolant	External / Internal coolant
H [mm]	120

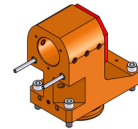

Accessories	N.A.
Notes	N.A.
Mounting tips	N.A.

Always check live tool dimensions on the turret

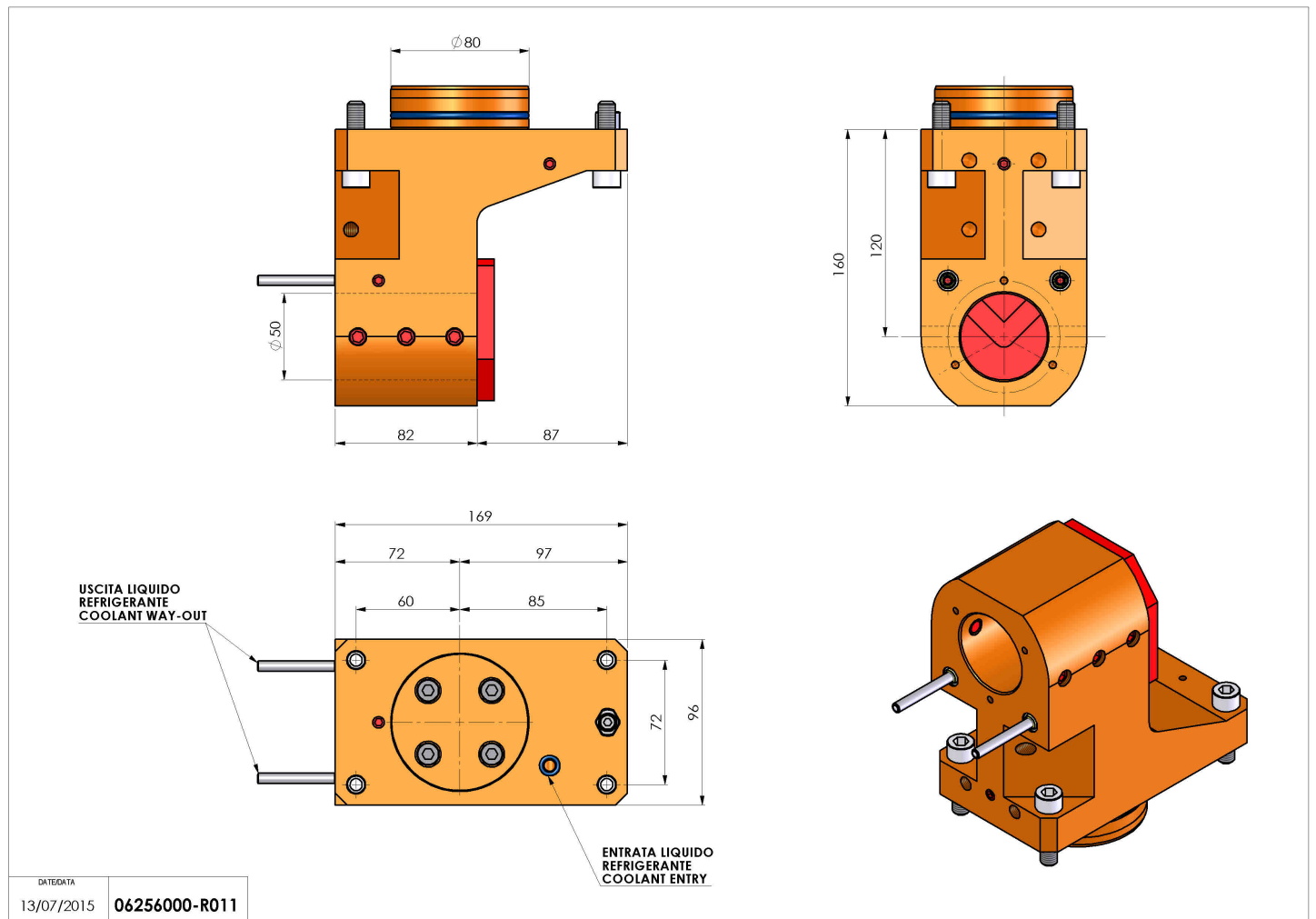

Subject to technical changes