

06255800 - TH-RAD D68 C40 OFS-75 RF H55

Type	TH-RAD Radial Tool holder
Mounting	CYLINDRICAL SHANK 68
Tool output	Polygonal shank C40 ISO 26623-1
Coolant	Internal coolant
H [mm]	55
Accessories	N.A.
Notes	N.A.
Mounting tips	N.A.

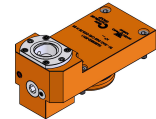

Always check live tool dimensions on the turret

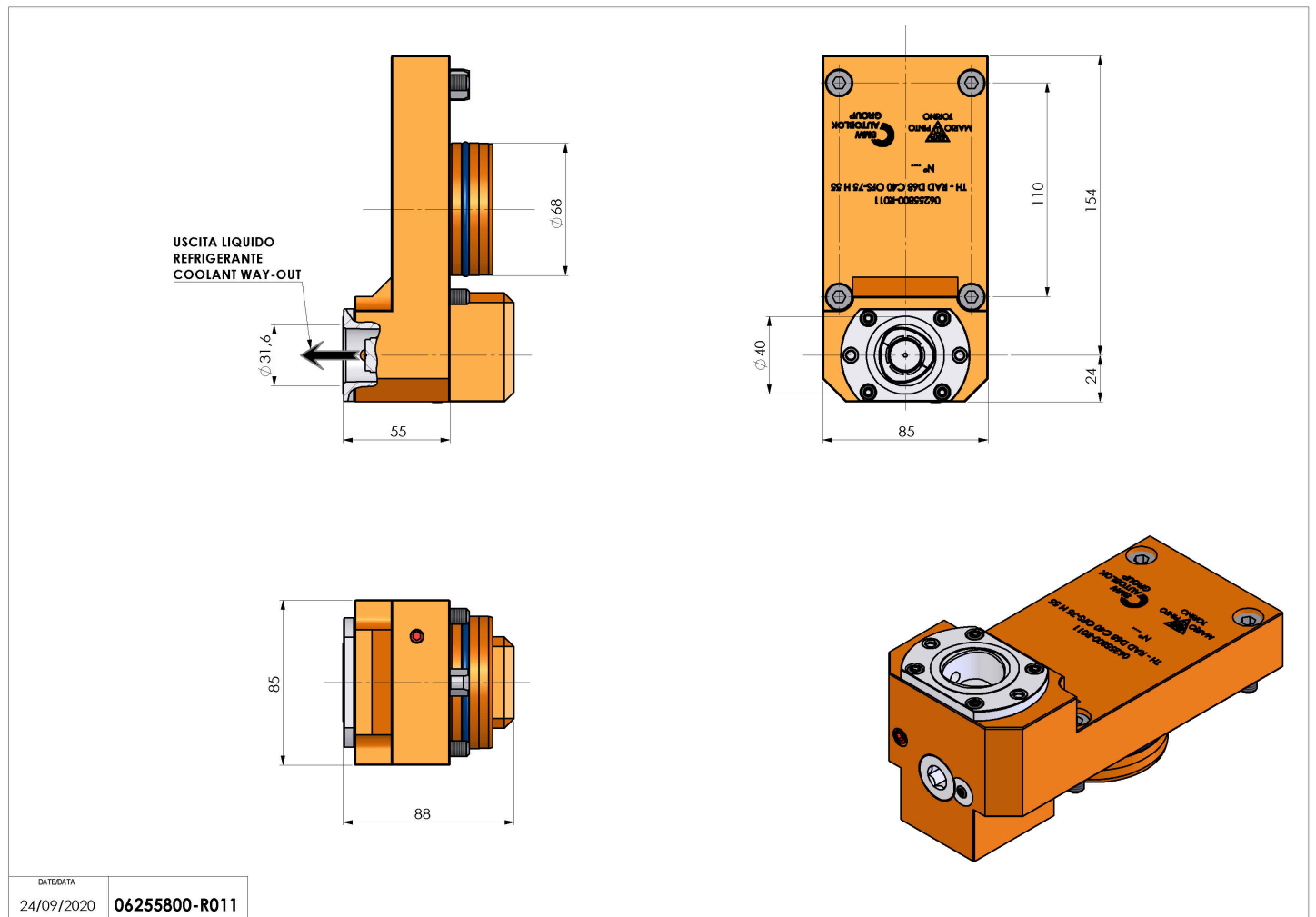

DATE/DATE	06255800-R011
-----------	---------------

Subject to technical changes