

# 06253400 - TH-BRB VDI50 D40H155L210 RF MZ

Type	TH-BRB Boring bar holder
Mounting	VDI 50
Tool output	Boring Bar Holder 40
Coolant	External / Internal coolant
H [mm]	155

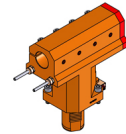

Accessories	N.A.
Notes	N.A.
Mounting tips	N.A.

**ATTENTION: CHECK THE ORIENTATION OF THE VDI TEETH**

Always check live tool dimensions on the turret

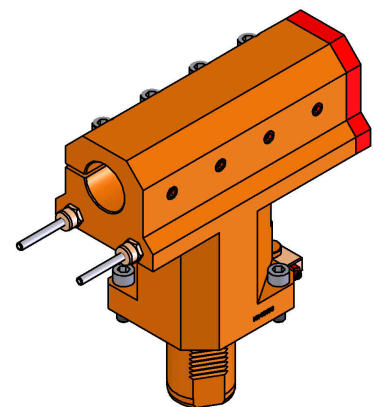
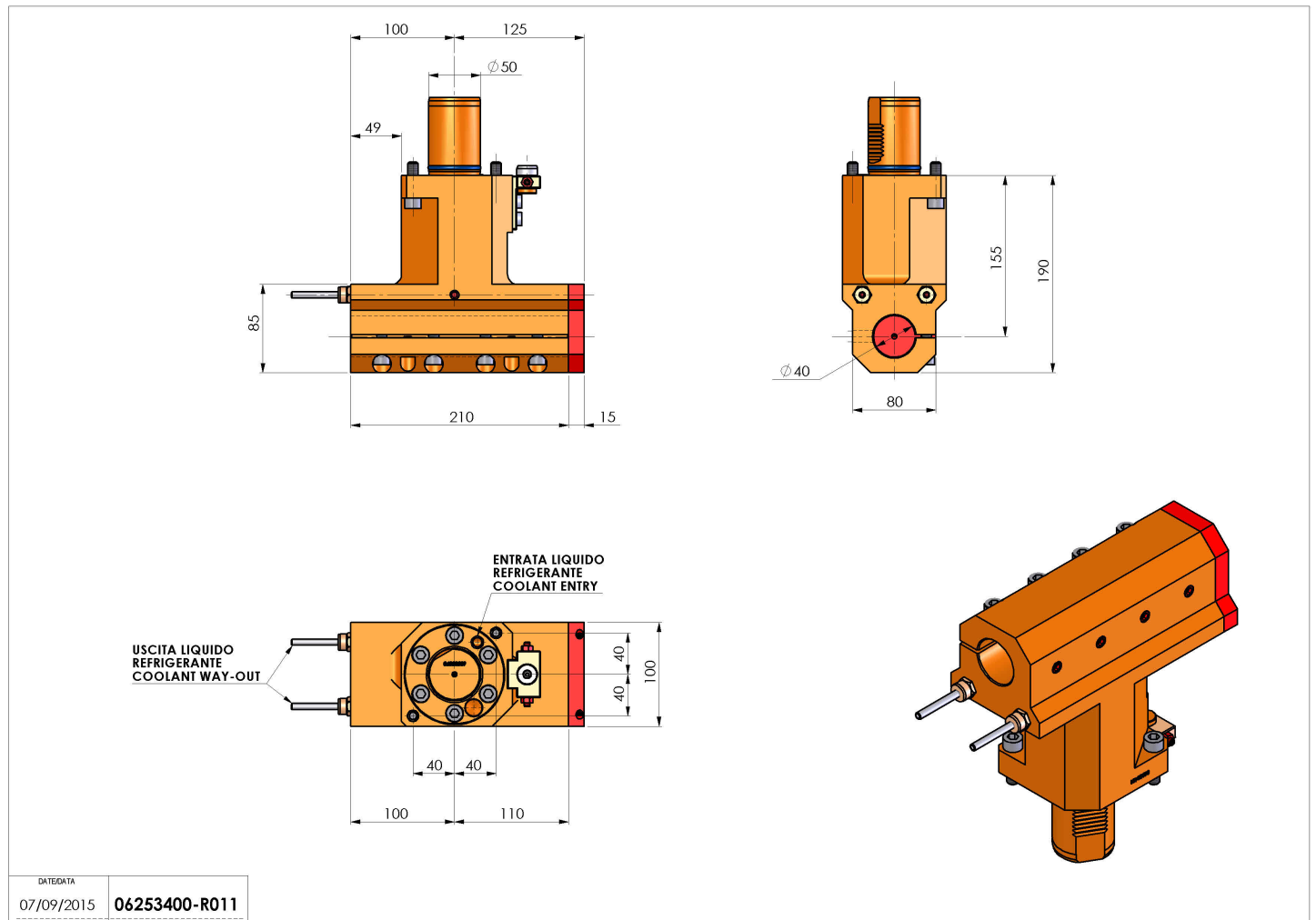

Subject to technical changes