

06150300 - TH-AX D44 C32 RF H73

Type	TH-AX Axial Tool holder
Mounting	CYLINDRICAL SHANK 44
Tool output	Polygonal shank C32 ISO 26623-1
Coolant	Internal coolant
H [mm]	73

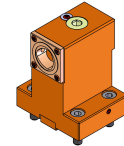

Accessories	N.A.
Notes	N.A.
Mounting tips	N.A.

Always check live tool dimensions on the turret

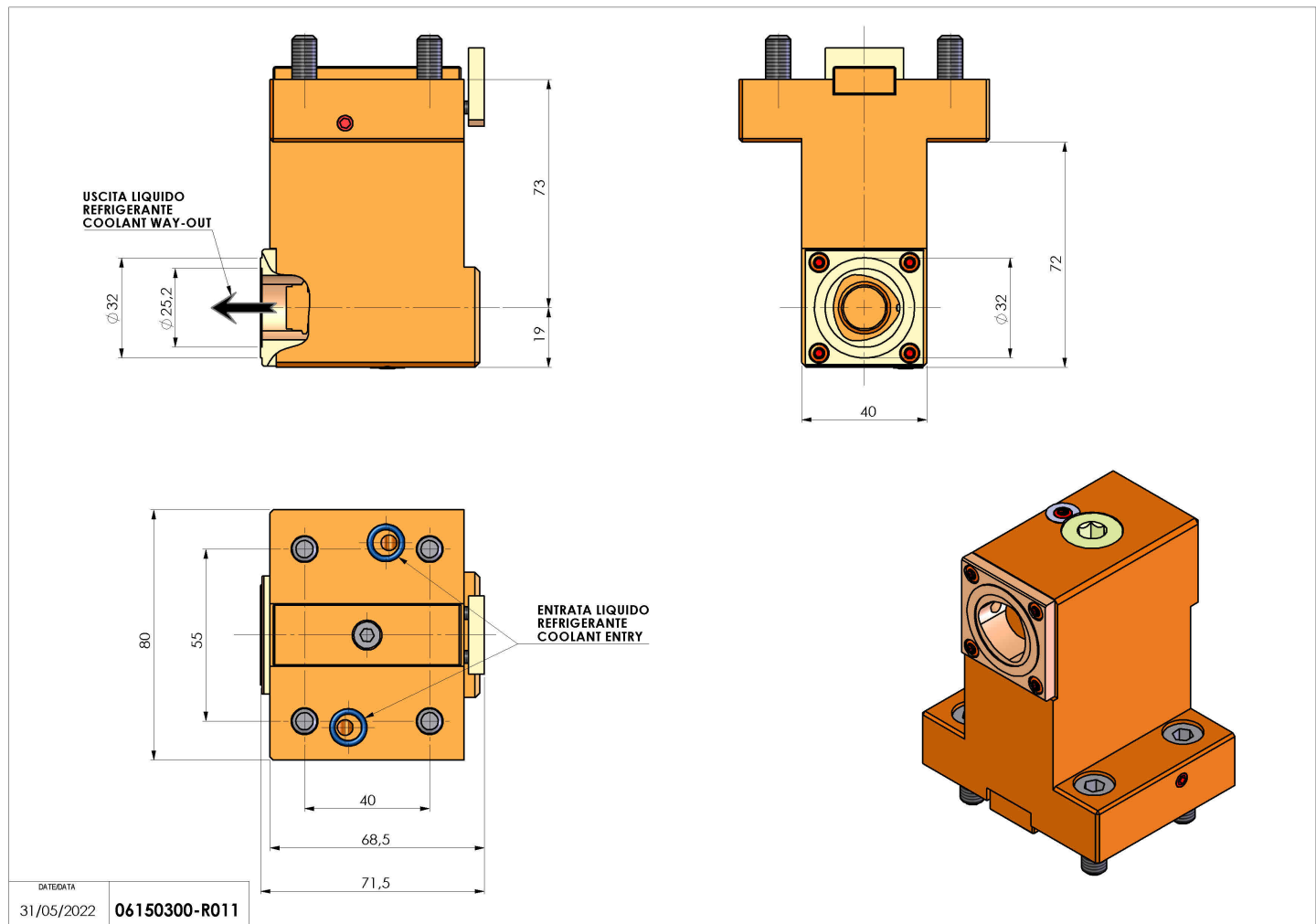

Subject to technical changes