

06064400 - TH-RAD D60 Q25 L-R H75

Type	TH-RAD Radial Tool holder
Mounting	CYLINDRICAL SHANK 60
Tool output	Radial Square Tool Holder 25x25
Coolant	External coolant
H [mm]	75

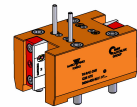

Accessories	N.A.
Notes	N.A.
Mounting tips	N.A.

Always check live tool dimensions on the turret

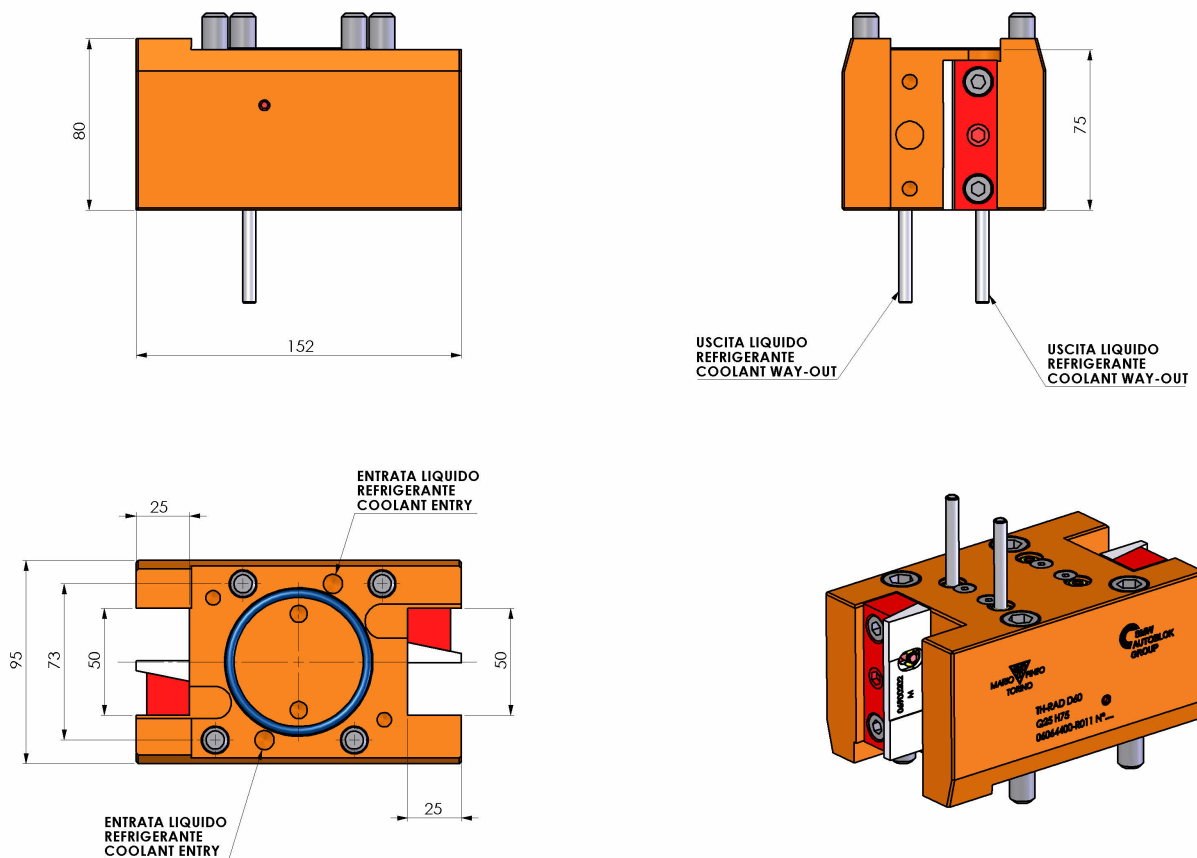

DATE/DATE	18/01/2019	06064400-R011
-----------	------------	---------------

Subject to technical changes