

06054600 - TH-RAD VDI50 H160 L86 DX-SX MZ

Type	TH-RAD Radial Tool holder
Mounting	VDI 50
Tool output	Radial Square Tool Holder 25x25
Coolant	External coolant
H [mm]	160

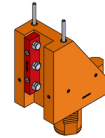

Accessories	N.A.
Notes	N.A.
Mounting tips	N.A.

ATTENTION: CHECK THE ORIENTATION OF THE VDI TEETH

Always check live tool dimensions on the turret

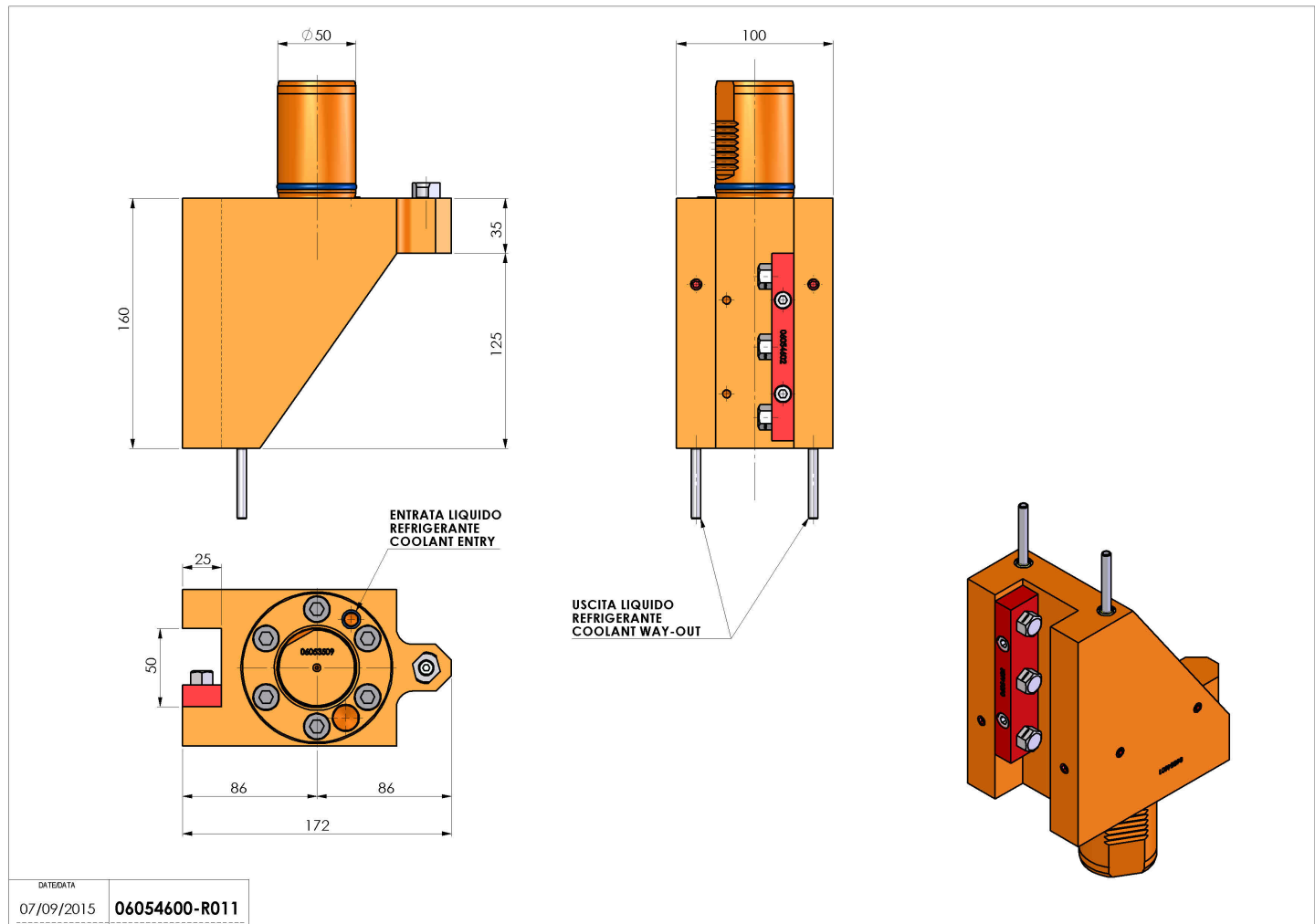

DATE/DATE	07/09/2015	06054600-R011
-----------	------------	---------------

Subject to technical changes