

06013000 - TH-BRB D55 D25 H75 NK

Type	TH-BRB Boring bar holder
Mounting	CYLINDRICAL SHANK 55
Tool output	Boring Bar Holder 25
Coolant	External / Internal coolant
H [mm]	75

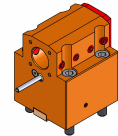

Accessories	N.A.
Notes	N.A.
Mounting tips	N.A.

Always check live tool dimensions on the turret

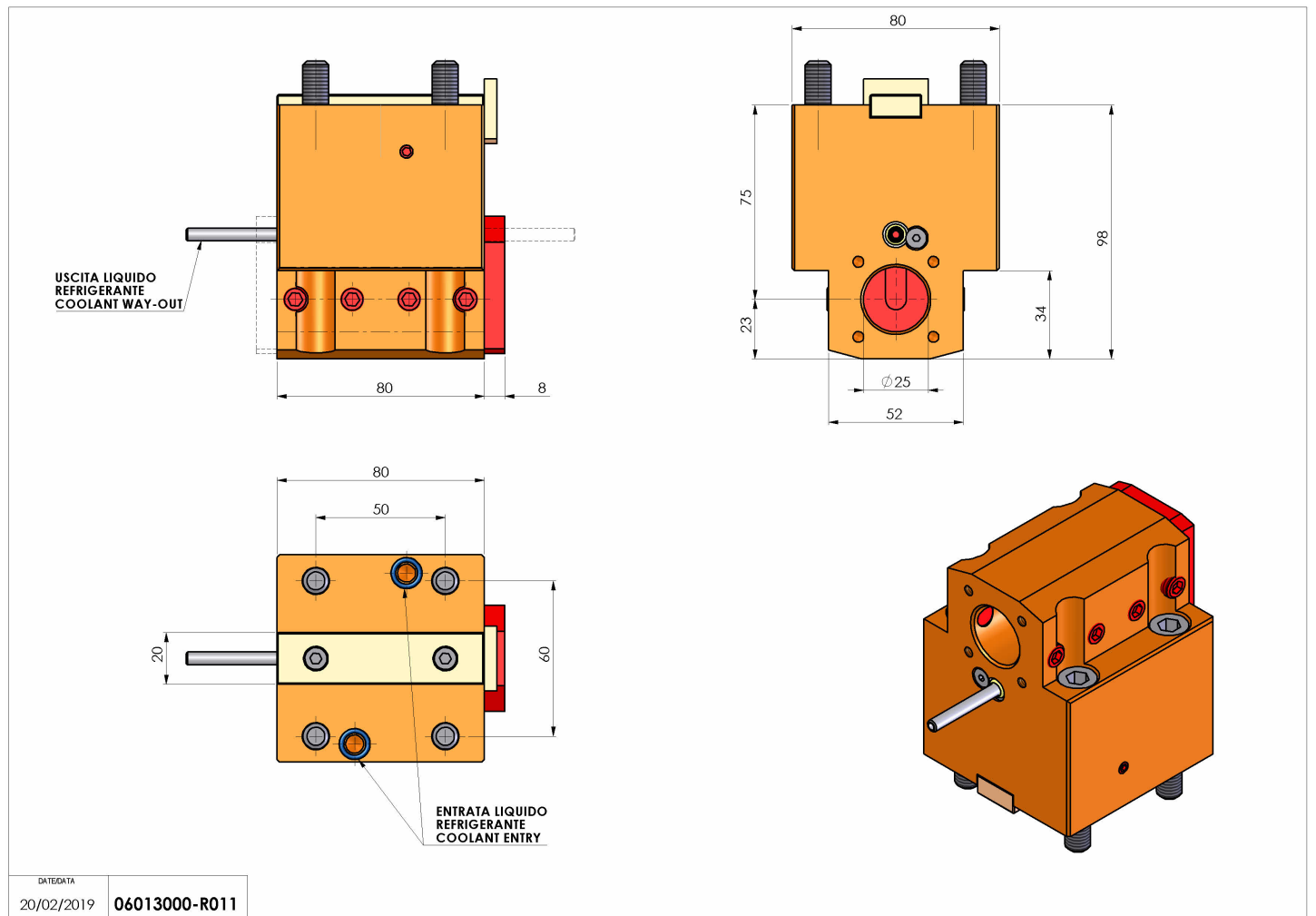

Subject to technical changes