

## 06011100 - TH-BRB D44 D25 H65 NK

Type	TH-BRB Boring bar holder
Mounting	CYLINDRICAL SHANK 44
Tool output	Boring Bar Holder 25
Coolant	External / Internal coolant
H [mm]	65
Accessories	N.A.
Notes	N.A.
Mounting tips	N.A.

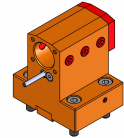

Always check live tool dimensions on the turret

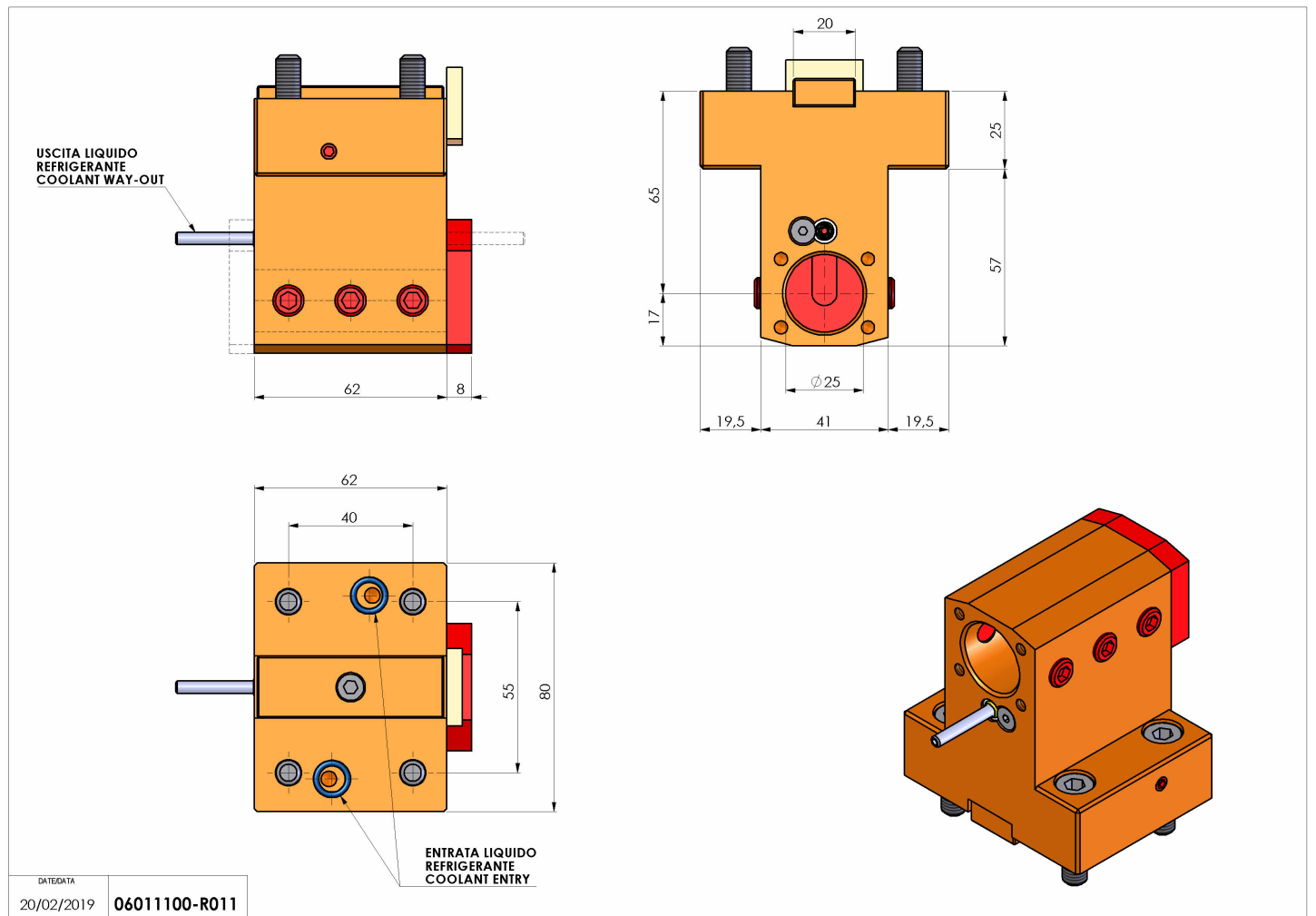

Subject to technical changes