

# 05401700 - LT-A D60 ER40 LR HRF H90

<b>Type</b>	LT-A Tool holder angle 90°
<b>Mounting</b>	CYLINDRICAL SHANK 60
<b>Tool output</b>	Collet nut ER 40
<b>Coolant</b>	HRF Internal coolant
<b>Direction of rotation</b>	r1  r2
<b>Max speed [rpm]</b>	6000
<b>Max torque [Nm]</b>	70
<b>Ratio</b>	1:1
<b>H [mm]</b>	90
<b>Max pressure [bar]</b>	80
<b>Accessories</b>	N.A.
<b>Notes</b>	N.A.
<b>Mounting tips</b>	N.A.

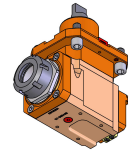

Always check live tool dimensions on the turret

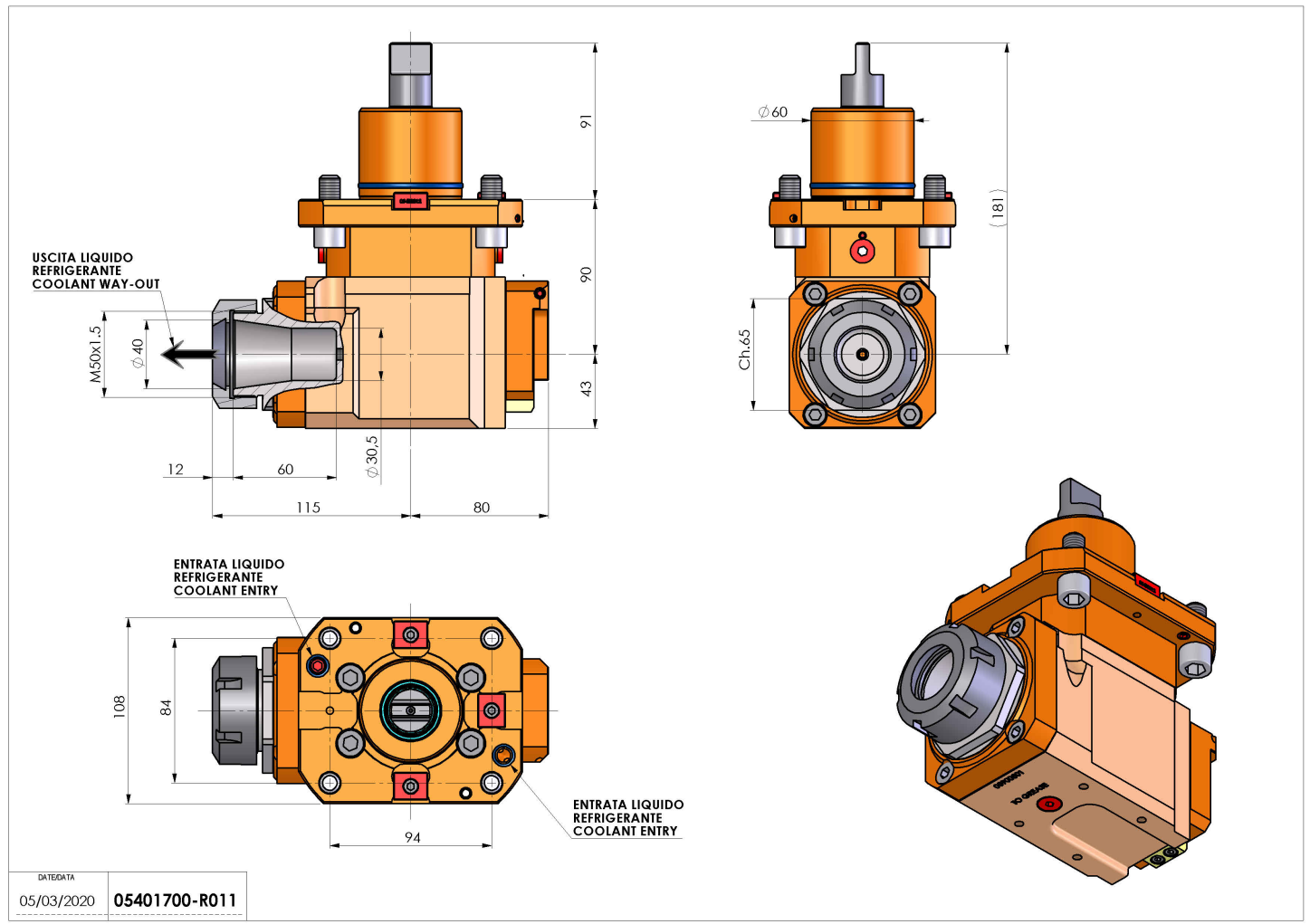

DATE/DATE: 05/03/2020  
**05401700-R011**

Subject to technical changes