

05314800 - LT-A BMT65 BD ER40 LR HRF H100

Type	LT-A Tool holder angle 90°
Mounting	BMT 65 BIG DRIVE
Tool output	Collet nut ER 40
Coolant	HRF Internal coolant
Direction of rotation	r1 r2
Max speed [rpm]	6000
Max torque [Nm]	63
Ratio	1:1
H [mm]	100
H1 [mm]	43
Max pressure [bar]	80
Accessories	N.A.
Notes	N.A.
Mounting tips	N.A.

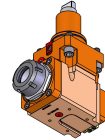

Always check live tool dimensions on the turret

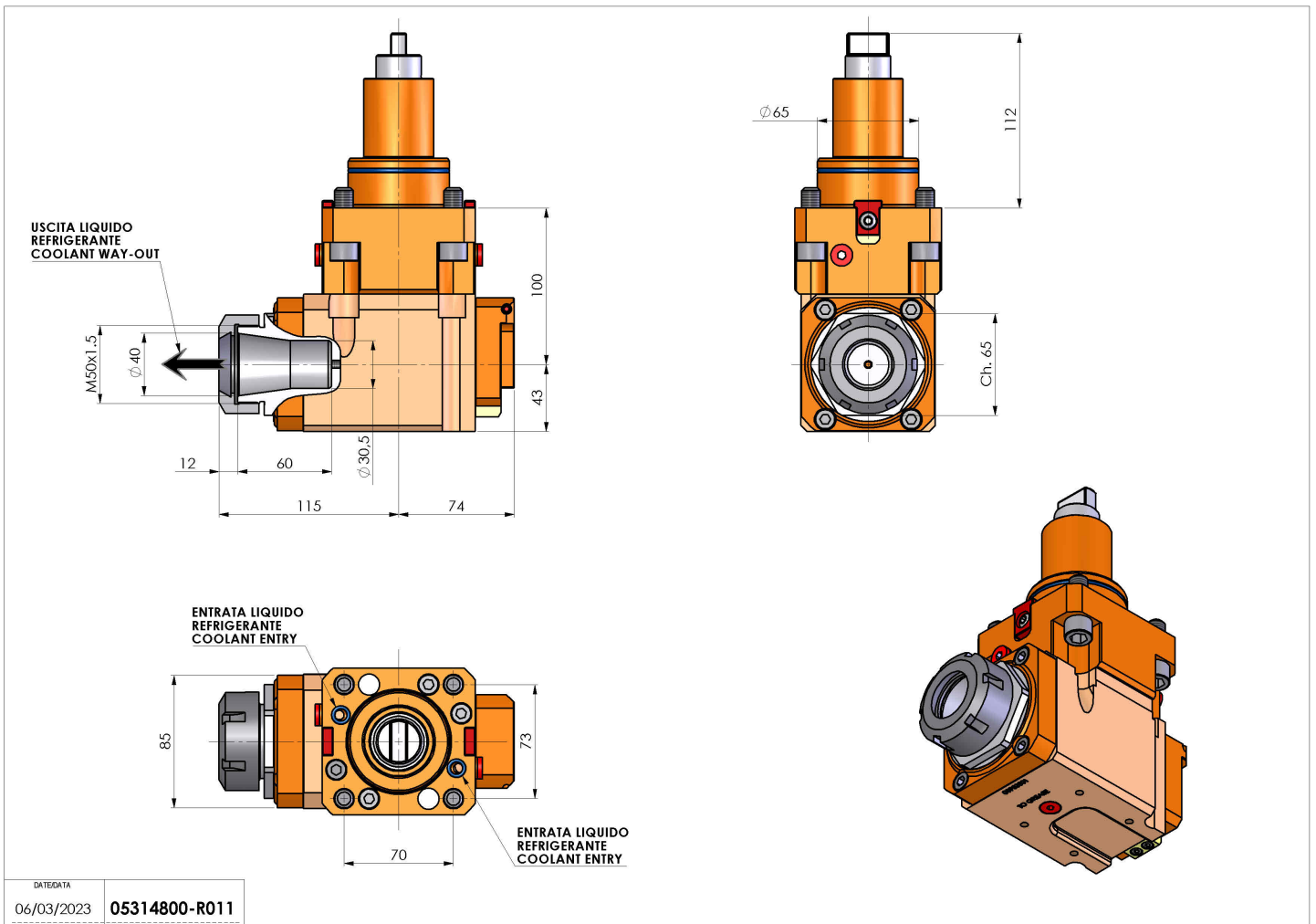

DATE/DATE: 06/03/2023 05314800-R011

Subject to technical changes