

05311800 - LT-S BMT55 BD ER25 RF H80

Type	LT-S Tool holder straight
Mounting	BMT 55 BIG DRIVE
Tool output	Collet nut ER 25
Coolant	Internal coolant
Direction of rotation	r1 r2
Max speed [rpm]	6000
Max torque [Nm]	60
Ratio	1:1
H [mm]	80
Max pressure [bar]	20
Accessories	N.A.
Notes	N.A.
Mounting tips	N.A.

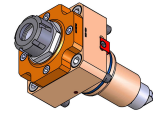

Always check live tool dimensions on the turret

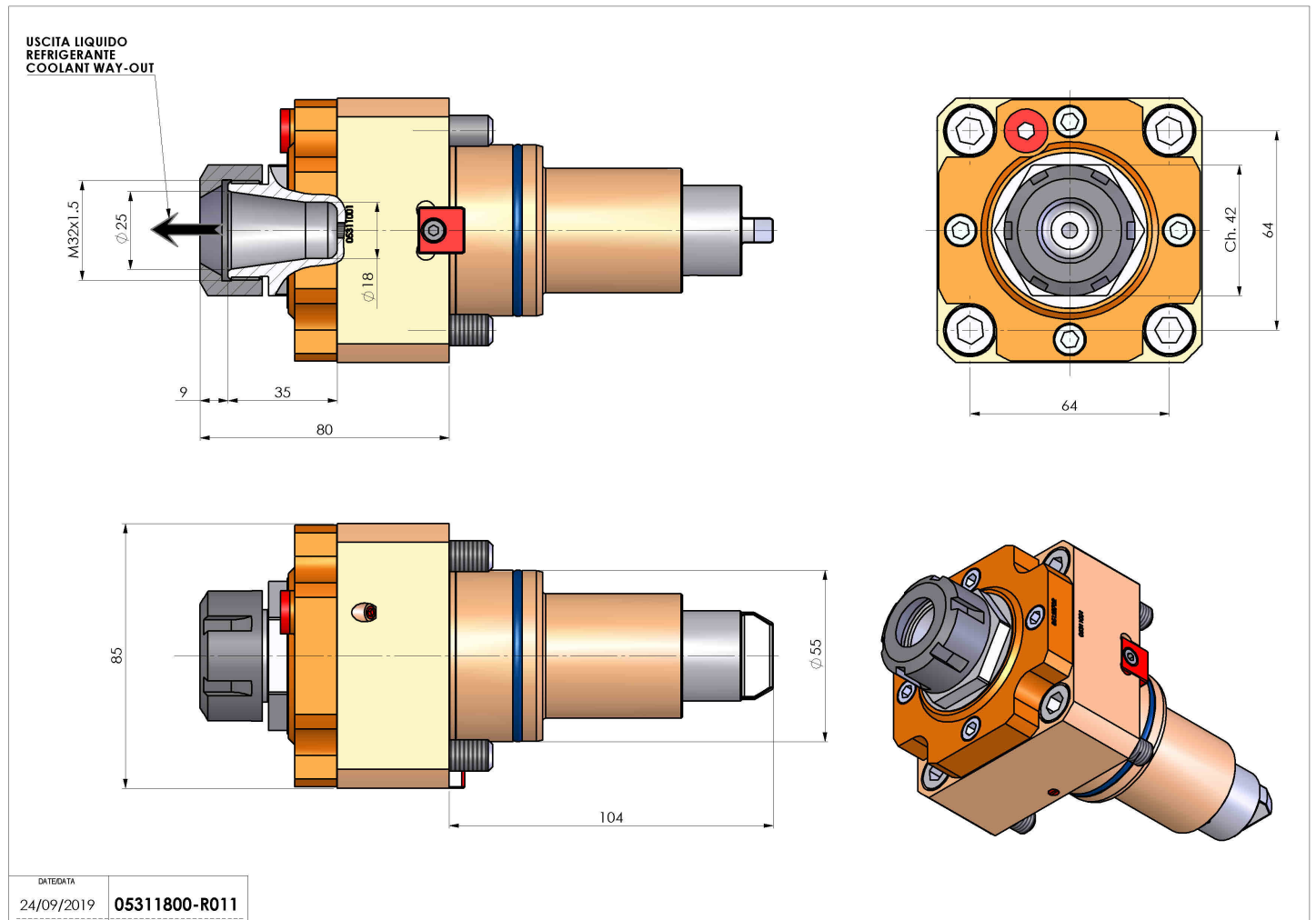

DATE/DATE	05311800-R011
24/09/2019	

Subject to technical changes