



05309300 - LT-S BMT45 ER25F H61

Type	LT-S Tool holder straight
Mounting	BMT 45
Tool output	Collet nut ER 25 F - internal nut
Coolant	External coolant
Direction of rotation	r1  r2 
Max speed [rpm]	6000
Max torque [Nm]	25
Ratio	1:1
H [mm]	61
Accessories	N.A.
Notes	N.A.
Mounting tips	N.A.



Always check live tool dimensions on the turret

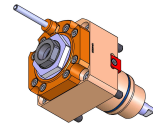
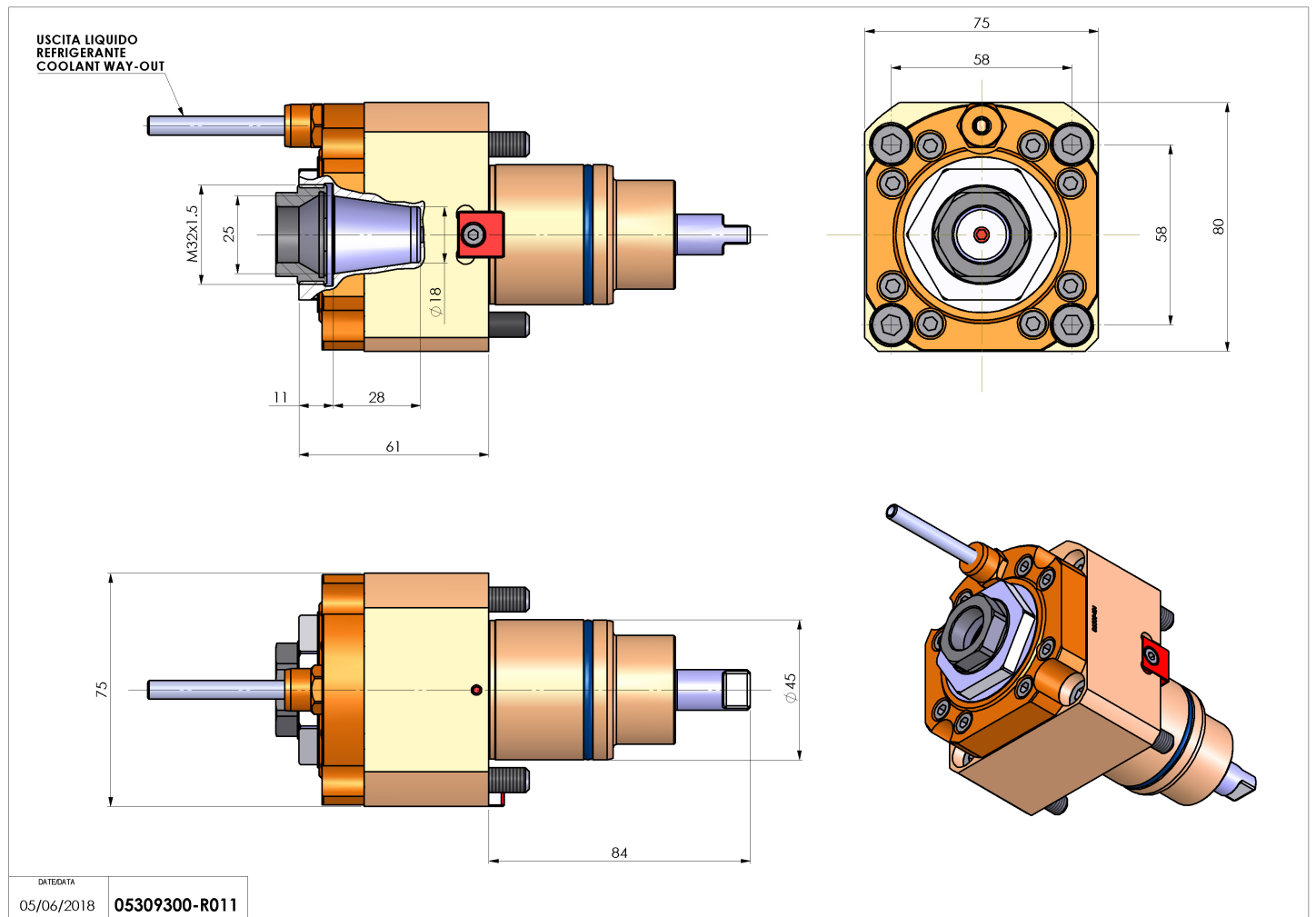

Subject to technical changes