

05308300 - LT-A BMT65 ER40F LR H100

Type	LT-A Tool holder angle 90°
Mounting	BMT 65
Tool output	Collet nut ER 40 F - internal nut
Coolant	External coolant
Direction of rotation	r1 ↻ r2 ↻
Max speed [rpm]	6000
Max torque [Nm]	63
Ratio	1:1
H [mm]	100
H1 [mm]	43
Accessories	N.A.
Notes	N.A.
Mounting tips	N.A.

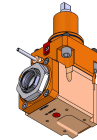

Always check live tool dimensions on the turret

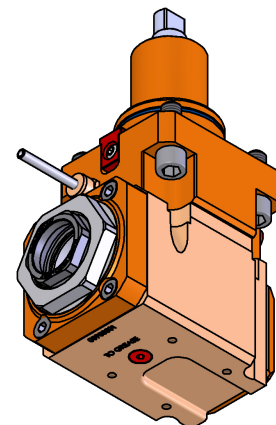
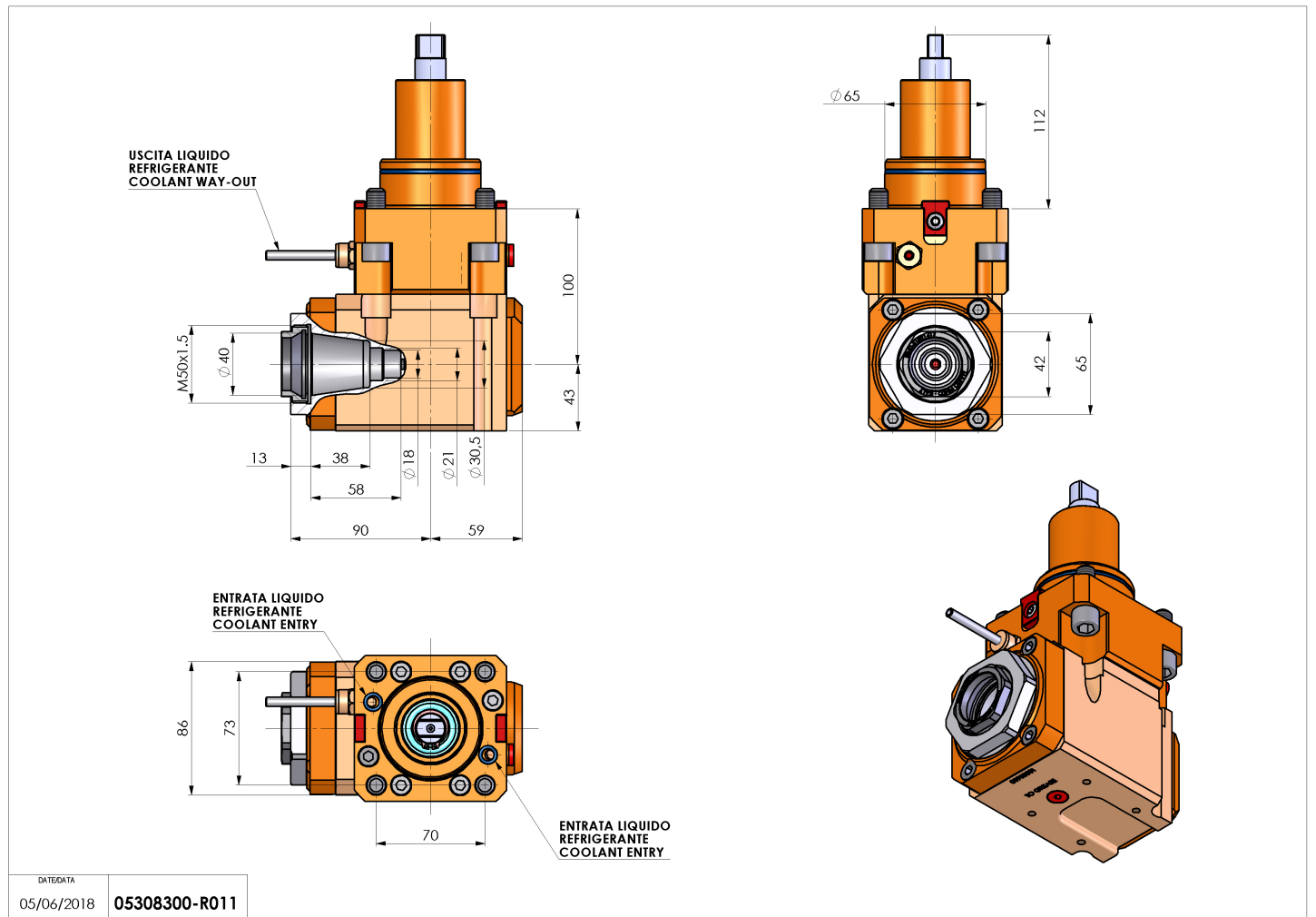

DATE/DATA: 05/06/2018
05308300-R011

Subject to technical changes