

# 05303800 - LT-A ST35 BMT65 C12 CR-AY H100

<b>Type</b>	LT-A ST Slotting tool 90°
<b>Mounting</b>	BMT 65
<b>Tool output</b>	Tool diameter 12
<b>Coolant</b>	External coolant
<b>Max speed [rpm]</b>	700
<b>Max torque [Nm]</b>	17,5
<b>Ratio</b>	1:1
<b>Y axis adjustment</b>	SI
<b>Feed pushing [N]</b>	1000
<b>Stroke [mm]</b>	35
<b>Work stroke [mm]</b>	30
<b>Y axis adjust. [mm]</b>	±0,4
<b>H [mm]</b>	100
<b>Accessories</b>	N.A.
<b>Notes</b>	N.A.
<b>Mounting tips</b>	N.A.

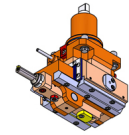

Always check live tool dimensions on the turret

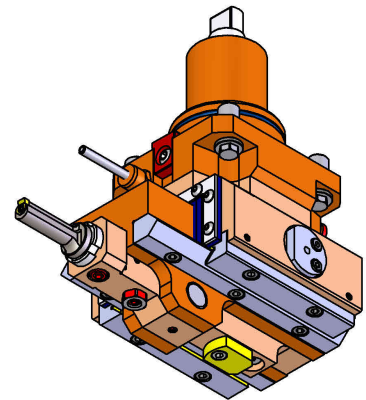
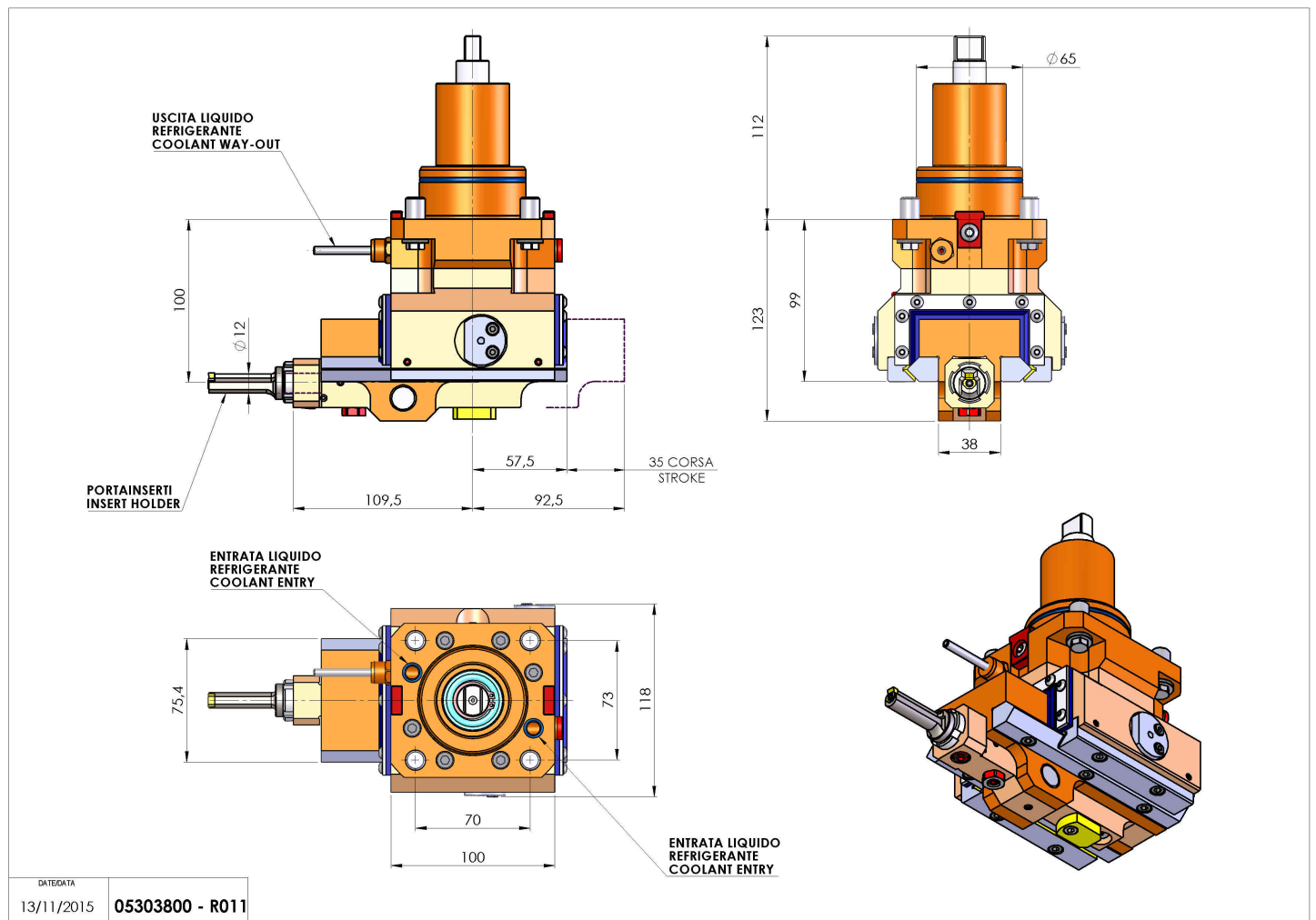

DATE/DATE: 13/11/2015  
**05303800 - R011**

Subject to technical changes