

05269200 - LT-S D60 ER40 H85

| | |
|------------------------------|------------------------------|
| Type | LT-S Tool holder straight |
| Mounting | CYLINDRICAL SHANK 60 |
| Tool output | Collet nut ER 40 |
| Coolant | External coolant |
| Direction of rotation | r1 r2 |
| Max speed [rpm] | 6000 |
| Max torque [Nm] | 40 |
| Ratio | 1:1 |
| H [mm] | 85 |
| Accessories | N.A. |
| Notes | N.A. |
| Mounting tips | N.A. |

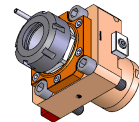

Always check live tool dimensions on the turret

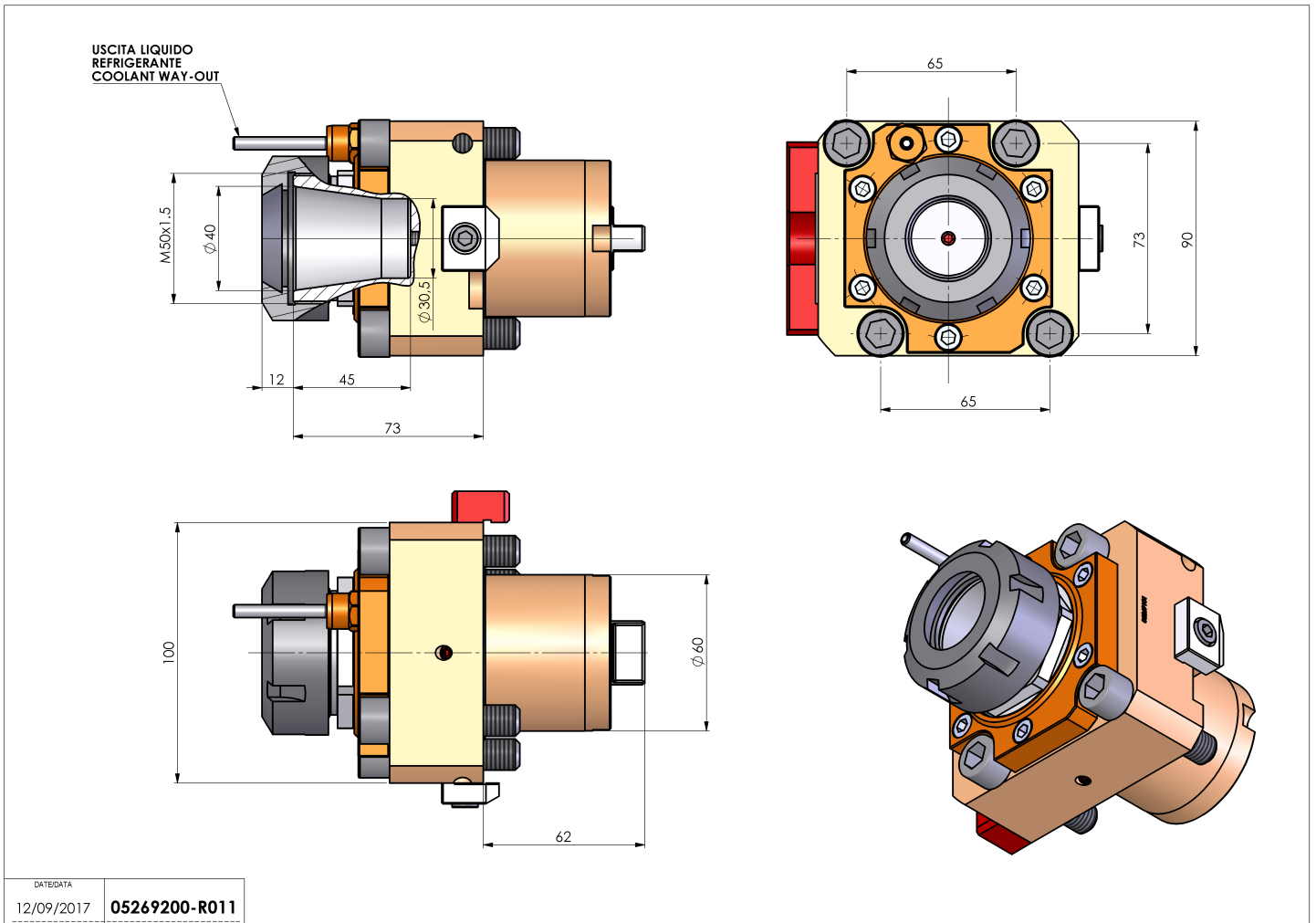

| | |
|------------|----------------------|
| DATE/DATA | |
| 12/09/2017 | 05269200-R011 |

Subject to technical changes