

# 05238900 - LT-S BMT55EM4 ER32F H60

<b>Type</b>	LT-S Tool holder straight
<b>Mounting</b>	BMT 55 EM
<b>Tool output</b>	Collet nut ER 32 F - internal nut
<b>Coolant</b>	External coolant
<b>Direction of rotation</b>	r1  r2
<b>Max speed [rpm]</b>	6000
<b>Max torque [Nm]</b>	60
<b>Ratio</b>	1:1
<b>H [mm]</b>	60
<b>Accessories</b>	N.A.
<b>Notes</b>	N.A.
<b>Mounting tips</b>	N.A.

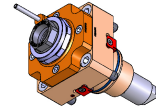

Always check live tool dimensions on the turret

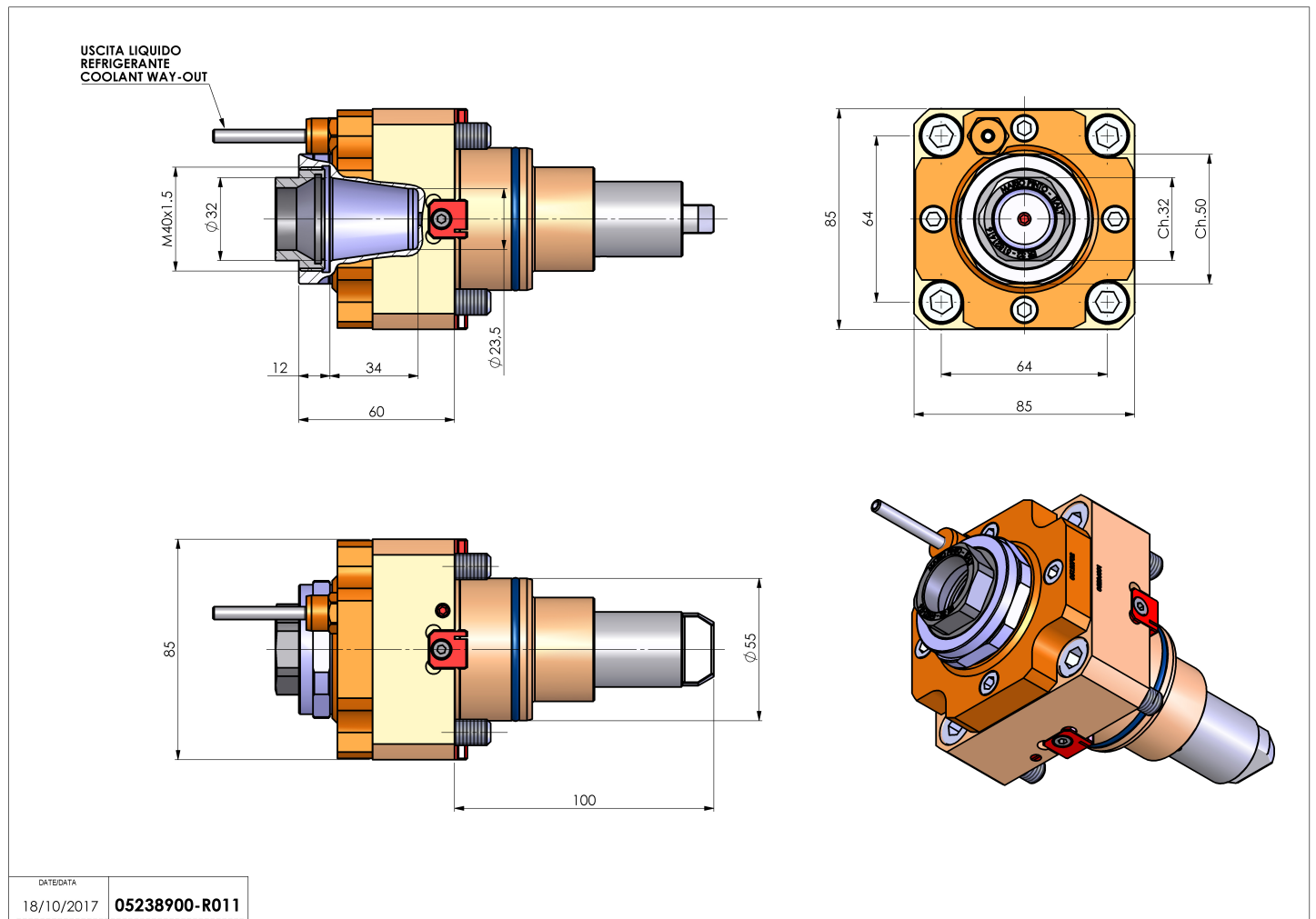

DATE/DATE	
18/10/2017	05238900-R011

Subject to technical changes